

Geometric Form in Adam Architecture?

David Fensom

Volume 11, numéro 1-2, 1984

URI : <https://id.erudit.org/iderudit/1074334ar>

DOI : <https://doi.org/10.7202/1074334ar>

[Aller au sommaire du numéro](#)

Éditeur(s)

UAAC-AAUC (University Art Association of Canada | Association d'art des universités du Canada)

ISSN

0315-9906 (imprimé)

1918-4778 (numérique)

[Découvrir la revue](#)

Citer cet article

Fensom, D. (1984). Geometric Form in Adam Architecture? *RACAR : Revue d'art canadienne / Canadian Art Review*, 11(1-2), 97–109.
<https://doi.org/10.7202/1074334ar>

Résumé de l'article

En 1758, le brillant architecte écossais Robert Adam (1728-1792) retourne en Grande-Bretagne au terme de ses voyages en Europe et s'installe à Londres. Il ramenait des croquis, plans, projets de décorations, et des artisans italiens qui l'aidèrent à instaurer une sorte de révolution néo-classique dans l'architecture anglaise du XVIII^e siècle. Aujourd'hui un bâtiment Adam accroche toujours l'attention par son élégance et son style particulier. Néanmoins, l'essentiel de ce style demeure difficile à préciser. L'auteur de cet article explore l'hypothèse du principe de géométrie unique qui aurait soutenu les rapports de proportions donnés par Robert et par son frère James au design des façades et des pièces intérieures de leurs bâtiments. Il semble en effet plus que probable qu'ils aient employé la section dorée de façon délibérée dans un nombre considérable de dessins. On sait que Robert Adam étudia la géométrie à l'université. Mais il employa aussi vraisemblablement la courbe conchoïdale pour donner une force expressive à son architecture; c'est donc dire qu'il aurait utilisé intentionnellement un système de proportions non palladien dans un style néo-classique. Ce système intègre au design architectural les nombres irrationnels, en particulier la suite de Fibonacci dont les éléments se rapprochent de la section dorée et de ses nombres relatifs. Il semble que cette géométrie ait été adoptée par Adam au retour de son séjour à Rome de 1754-1758, et qu'il ait partagé ce secret de composition avec G.B. Piranesi, à une époque où peu d'architectes comprenaient son impact.

*Geometric Form in Adam Architecture?**

DAVID FENSOM

Mount Allison University, Sackville, N.B.

In 1758 Robert Adam, the brilliant Scottish architect (1728-92), returned to Britain from his travels in Europe and set up his office in London. He brought with him sketches, plans of buildings, ideas for decoration and Italian craftsmen who helped him to initiate a 'kind of revolution' in the neo-classical English architecture of the 18th century. Today an Adam building still catches the eye by its distinctive gracefulness and style. Nonetheless the essence of 'Adam-ness' is extremely difficult to pin down. Much has been written about Adam architecture and this article is not intended to review the considerable material which has been compiled. Rather it is an attempt to explore in a new way the possibility that a single principle in geometry might underlie the proportions Robert and James used in the design of their rooms or in the façades of their buildings. Indeed it seems highly probable to me that they deliberately employed the Golden Section in a surprising number of their designs.

The reasons for these conclusions are elucidated in the following two sections.

I — THE SEARCH FOR GEOMETRICAL RULE

The rules and orders of architecture are so generally known, and may be found in so many books, that it would be tedious, and even absurd, to treat them in this work. We beg leave, however, to observe that among architects destitute of genius and incapable of venturing into the great line of their art, the attention paid to those rules and proportions is frequently minute and frivolous. The great masters of antiquity were not so rigidly scrupulous, they varied the proportions as the general spirit of their composition required, clearly perceiving, that however necessary these rules may be to form and taste, and to correct the licentiousness of the scholar, they often cramp the genius and circumscribe the ideas of the master.¹

These remarks by Robert and James in the Preface of their famous artistic apologia *The Works in Architecture* have often been quoted. In particular they are used to support the belief that the Adam brothers avoided any regular rules of geometry or mathematical pattern in the design of their buildings. This can be shown to be untrue. Certainly they departed from the rigid rules then generally in use for the proportions and design of columns. Also the façades of the buildings, while seemingly Palladian, were not at all strictly so. They did not, for instance, design façades with proportions 1:2, 1:3, or 2:3 as Andrea Palladio,² Lord Burlington or William Kent had done. Nor did they design 'double cube' rooms as did Inigo Jones. In Scotland both Sir William Bruce and their father, William Adam, had been concerned with Rule and the use of simple whole numbers in their proportions. For instance, Kinross House (Fig. 1) is essentially a design based on three squares, one large one in the centre, 36' × 36', and two smaller ones, 25' × 25' on the wings. Similarly, Moncrieff House (Fig. 2) can be designed from two squares side by side,

* This study was made possible by a Canada Council Senior Killam Research Scholarship. It is a pleasure to acknowledge the assistance of Sir John Clerk of Penicuik, Mr. Keith Adam of Blair Adam, Dr. W.S. Sim, Dr. E.J. Williams, the late John Martin R.C.A., the able staffs of the Sir John Soane's Museum, London, and also of the Register House, Edinburgh. In particular I am indebted for the advice and comments of Sir James Taylor of the Royal Society of Arts, and Professor Alastair Rowan of Dublin University. The line drawings by Colin Munro and much patient help from K.M.F. are also gratefully acknowledged.

1 Robert and James Adam, *The Works in Architecture*, Part 1, Vol. 1 (London, 1773), Preface.

2 Rudolf Wittkower, *Architectural Principles in the Age of Humanism* (London, A. Tiranti, 1952).

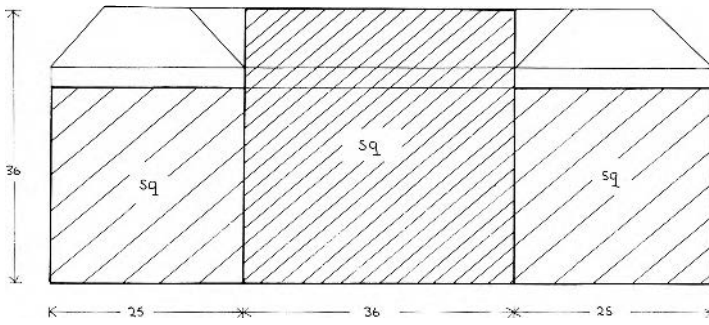

FIGURE 1. Sir William Bruce, *Kinross House, Fife*, ca. 1685 (Drawing: Colin Munro).

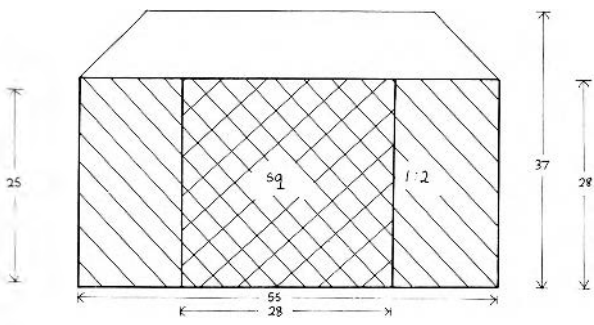
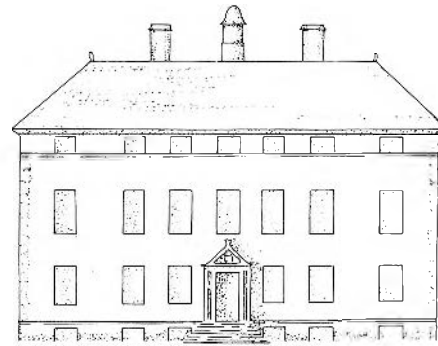

FIGURE 2. Sir William Bruce, *Moncrieff House, Perthshire*, ca. 1679 (Drawing: Colin Munro).



each $28' \times 28'$, or by one central square, $28' \times 28'$, flanked by two rectangles, each $14' \times 28'$.

Robert and James apparently started to work in this way in their father's office. The first works of importance generally attributed to them were the pavilions of Hopetoun House near Edinburgh, the house whose centre block was designed by William Adam for Lord Hopetoun in the 1730s. The pavilions have their main visual length-height proportions very close to 1:4, a simple ratio, if slightly unusual. The gracefulness of these wing-pavilions lies more in the treatment of central tower and lightness of window design than in overall proportion.

The next great commission was for Dumfries House (1754) in Ayrshire. The design (Fig. 3) is strictly Palladian: whole number relations exist between height, width and all the main lines which catch the eye. The Central Block is essentially composed of three squares, each about $46'$ a side, all raised upon a common base. The pavilions are symmetrical rectangles, $42' \times 83'$, and therefore 1:2 in proportion. They are arranged around the central structure which is based on 1:3.

Then came Robert's trip to Rome, 1754-58. Upon his return his geometry had altered and seemed to be continually varied with little or no regular mathematical theme. No longer can one see the simple dependence on small whole number relations. For instance, the rear elevation of Kenwood House (Fig. 4) has wing pavilions $66' \times 20'4"$, while the central block is $80' \times 37'9"$. These proportions are pleasant to look at and at first glance somewhat similar to those of Dumfries House, but they are not simple ratios of integers at all.

On what theme did Robert base his thinking? Had he any training in mathematics? Did he never use mathematical devices to obtain his effect? Some people think not – Sir John Summerson has the feeling that Robert was designing everything out of his head.³ Was everything designed in his mind's eye to appear on paper and then in stone as a graceful and satisfying form? He has not written about his principles of design but were his designs really devoid of rules? All architects think in terms of pattern or form.

Had Robert any training in mathematics? Yes, we know he attended both the High School and the University of Edinburgh. At the University he studied mathematics under Professor Maclaurin and seems to have been duly enthused by him, for

3 John Summerson, *Architecture in Britain, 1530-1830* (Harmondsworth, Penguin Books, 1970), 424-441.

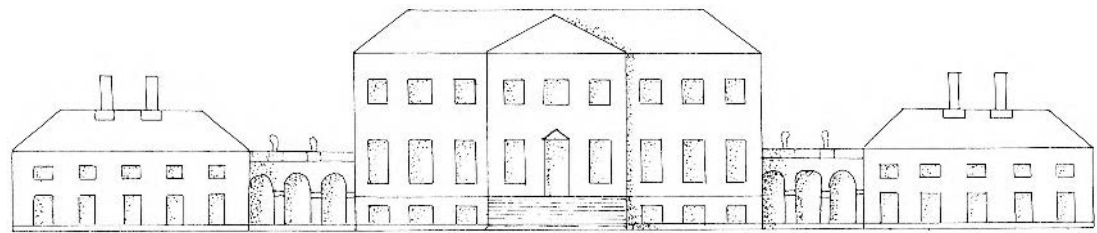
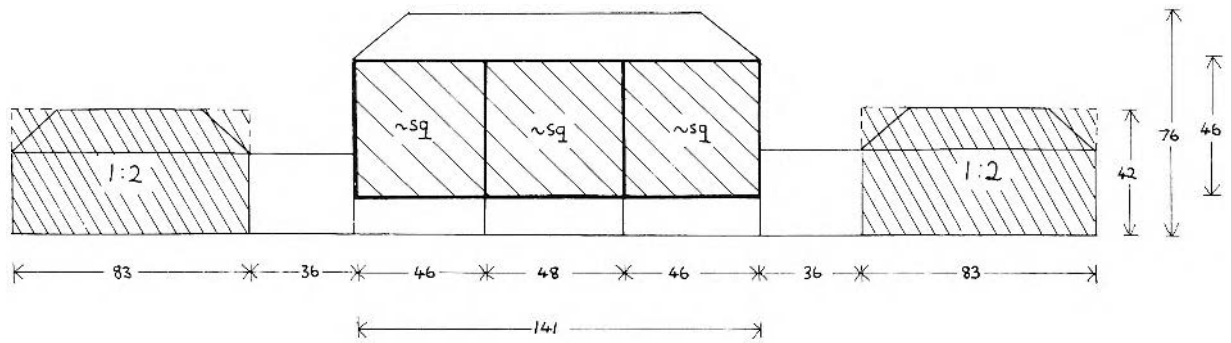

FIGURE 3. John, Robert and James Adam, *Dumfries House, Ayrshire, 1754* (Drawing: Colin Munro). Measurements from original drawings, courtesy Lord Bute.

he 'took pleasure in repeating and explaining to his sisters the lectures he heard' (wrote John Clerk of Eldin).⁴ Clever Scot that he was, it is difficult to imagine that as an architect's son he did not play with geometry, attempting to trisect an angle or construct magic squares as all able schoolboys try to do. Perhaps he heard from Maclaurin about Sir Isaac Newton and the 'first conchoid' curve. Maclaurin was a great admirer of Sir Isaac and indeed was nominated by Newton to the Chair of Mathematics at Edinburgh. Newton stressed that the conchoid should be treated as a 'standard curve'⁵ because of its importance in applied geometry like trisecting an angle or doubling a cube. Certain it is that Robert studied some mathematics and was enthusiastic about his own geometrical accumen.

Did Robert Adam ever use particular mathematical devices to obtain his effects? Yes, in spite of the suggestion that rules were made for lesser mortals than 'masters', the *Works in Architecture*, specifically state: 'Our constant practice has been to diminish our columns from the base to the capital by means of the instrument used by Nicomedes for describing the first conchoid, which we think has exceeded in elegance any other method hitherto employed.'⁶ This was their mathema to produce entasis.

Now this is indeed a mathematical device, for the Adam brothers go on to say that 'as this instrument and the method of using it, have already been explained by some modern authors, we should not here have ventured to mention it, had it not been to recommend it as preferable to all others.' Most of the books on architecture written in English between 1730 and 1830 make no reference either to Nicomedes or the conchoid curve, nor can it be found in common architectural references today. In other words, the Adam brothers used a mathematical device to create their entasis which was not then generally referred to by its mathematical name in British architectural books. Even the term 'first conchoid' is not now in common architectural dictionaries. But in reference books on mathematics it can be located: 'conchoid, a curve devised by Nicomedes, Greek mathematician (ca. 180 B.C.) who used this curve to trisect the angle, or to double the cube.'⁷

4 Clerk of Penicuik papers, Draft notes on a life of Robert Adam, GD 18, #4981. Historical Records Section, Register House, Edinburgh.

5 E.H. Lockwood, *A Book of Curves* (Cambridge, Cambridge University Press, 1963).

6 Robert and James Adam, *The Works in Architecture*, Part II, Vol. 1 (London, 1774), Preface.

7 D.E. Smith, *History of Mathematics* (New York, Ginn & Co., 1925), 298.

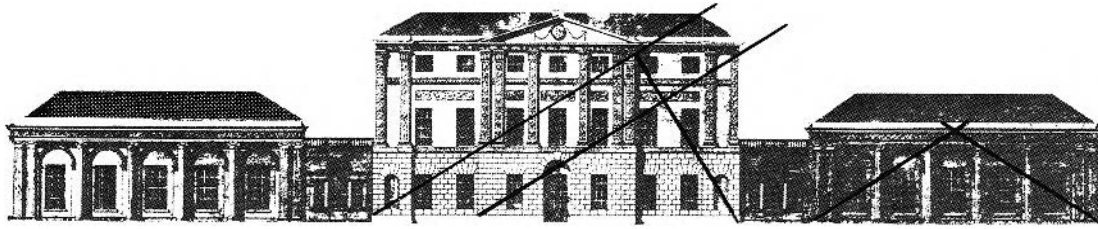

FIGURE 4. Robert Adam, *Kenwood House, London, 1767*, south front (from *The Works in Architecture*, 1, n° 11).

The device used to draw the first conchoid is called a trammel and is shown in Figure 5. This figure is taken from a French translation of Jacopo Barozzi Vignola's Italian treatise⁸ which refers by name to the first conchoid and to Nicomedes. This work was translated into French sometime after 1735, for in it is mentioned François Blondel whose *Cours d'Architecture* was famous. Sir William Chambers, Robert Adam's greatest rival, studied for a year in Paris under Jacques-François Blondel and refers to a practical way to use the conchoid to produce entasis,⁹ so by 1770 it was available to English architects.⁹ Yet Batty Langley,¹⁰ the British author of many books on architecture presents it as a 'method of diminishing columns used by the ancients,' but does not call it 'conchoid' or attribute its origin to Nicomedes. Thus these terms seem to have disappeared from British architectural plans-books. Robert Adam could read Italian and French and would have had German and Dutch authors to consult as well. Nonetheless this is a mathema indeed! To know about the conchoid and employ it with finesse does take considerable mathematic acumen, but as used in a draughting office it is very easy to apply. For instance, the straight board FG in Figure 5 is placed along the centre line of the column with DE at right angles to it. The stick HEBA slides around the pin E so that the fixed distance FA (= BC) describes a curve around the column axis as HA slides along FG.

So it is clear that the Adam brothers did use a mathematical device or rule to produce their entasis. About proportions of buildings, however, they say nothing at all. On the other hand they comment on the proportions of columns:

The proportion of columns has also been a subject of much inquiry. But as this greatly depends on the situation, whether they make parts of inside or outside decoration, whether they stand insulated or engaged, whether raised much above the eye or level with it; these are circumstances which very much alter such proportions, and consequently have an uncertainty which can only be properly ascertained by the correct tact of the skilful and experienced artist.

Nonetheless, they generally started with a height to breadth ratio of 7 to 10 diameters which was then a very common practice (see Batty Langley or Vignola's treatise). The volute of Ionic columns, on the other hand, was often drawn so that its diameter was half that of the top of the column (*Works*, Part II, preface), a simple but effective rule to use.

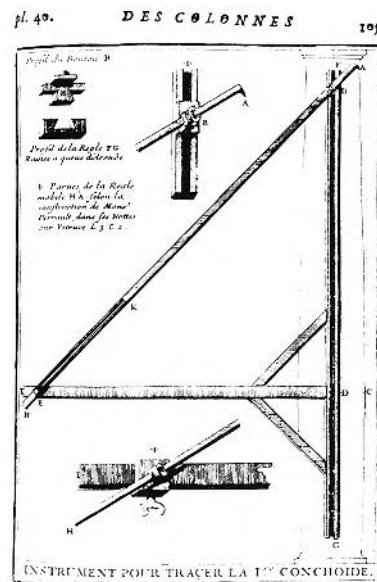

FIGURE 5. Trammel, 'Instrument of Nicomedes' (from J.B. Vignole, *Cours d'Architecture qui comprend les ordres de Vignole*, par A.C. Daviler, Paris, 1720, 1).

8 J.B. Vignole, *Cours d'Architecture qui comprend les ordres de Vignole* par A.C. Daviler (Paris, 1720), Vol. 1.

9 *The Dictionary of Architecture*, 'Entasis,' instrument of Nicomedes used by Sir William Chambers (London, Architectural Publication Society, 1887), 46-47.

10 Batty Langley, *Ancient Masonry, useful rules of Arithmetic, Geometry and Architecture*, 1-II (London, B. Langley, 1736).

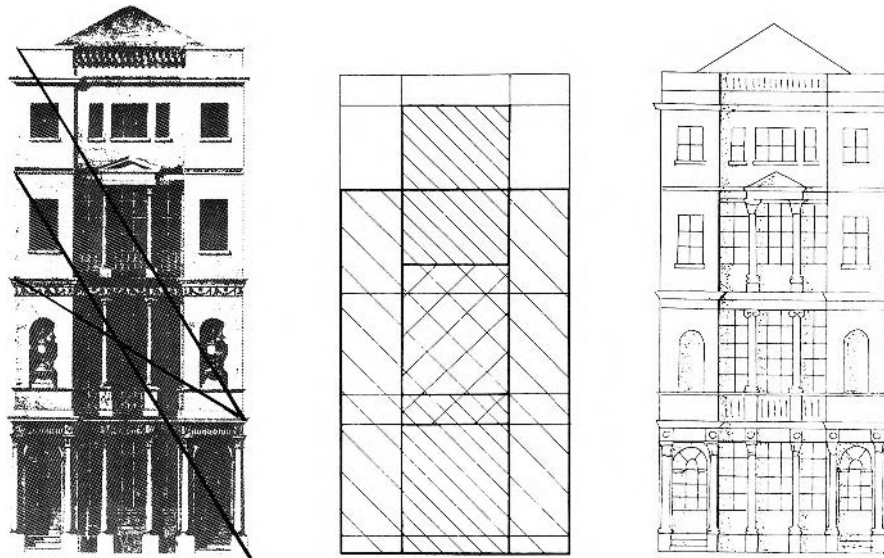

FIGURE 6. Robert Adam, *The British Coffee House*, 1770 (from *The Works in Architecture*, II [1779]), with drawings by Colin Munro.

In *The Works in Architecture* the brothers continually stress two things: that other designers tend to work by a pedantic set of rules (e.g. Batty Langley's rules for columns) but that they themselves varied their forms to suit circumstances and therefore followed no one rigid system. Yet we know that they did follow certain patterns of decoration; the use of the classical motif in repetition; the use of curves in symmetry. Their proportions have often been classed as 'noble' or 'elegant'. The question is why?

So much for columns, entasis, and the mathematical form used by the Adam brothers to produce them. What about the famous interior decorations? What about façades of buildings? Was a system of proportions used in their design? If some system were used, it has not been stated explicitly, either in the *Works*, or in the sketchbooks or drawings preserved.

The question remains: what makes an Adam design so distinctive? However, there are ways to search. A similar problem existed with the works of Andrea Palladio, the sixteenth-century Venetian, which was largely resolved in this century by Rudolf Wittkower. In his *Architectural Principles in the Age of Humanism*, Wittkower sets out to 'prove' that Palladio had deliberately used a system for his proportions. But he sagely remarks that 'in trying to prove that a system of proportions has been deliberately applied by painter, sculptor or architect, one is easily misled into finding in a given work those ratios which one sets out to find ... If we want to avoid the pitfalls of useless spe-

culatation, we must look for practical prescriptions of ratios supplied by the artists themselves ... One must, above all, be able to decipher and interpret the artist's indications.'¹¹ That is decipher the actual dimensions set down by the architect on his drawings. Measurements of the finished building are seldom exact enough, builders were never particularly exact, nor were scale measurements of paintings or old prints.

This caveat certainly applies to the works of the Adam brothers. Except for the specific reference to the 'instrument of Nicomedes' used to create entasis, and to the proportions of columns or volutes, there are no 'proofs' that other systems of design were deliberately employed. Yet a large number of Adam drawings do contain the artist's own dimensions on them, and drawings in *The Works in Architecture* are, unlike Palladio's, so carefully drawn to scale that in lieu of exact printed dimensions, scale measurements may confidently be used. Robert Adam's specific dimensions almost all have gaps between their measured parts. But the gaps are small and also to scale, and the measured engravings or the dimensioned drawings both support strongly the contention that mathematical forms were deliberately applied by the architect.

In Figure 6, I have shown a drawing of the front façade of the British Coffee House from the *Works in Architecture* of 1773. The original Adam drawing is reproduced at the left, and a simplified

¹¹ Wittkower, 110.

drawing at the right. Between them is an exact duplication of the right-hand drawing overlaid with rectangles similar to those shown in Figures 1, 2 and 3. These rectangles are all based on the Golden Section,¹² repeated and overlapping or turned on end, but all have length to breadth proportions of the Golden Section, namely 1.618 to 1.00. A similar design analysis has been done by me with Figure 4, though not here shown. But while this sort of exercise suggests that the Adam brothers used a principle of geometry in designing these two façades, the drawings of rectangles are, after all, my own and are based on but two reproductions of Adam designs.¹³ What about the original designs? What about an extended use of the Golden Section? How can one explore the possibility that this proportion, namely 1.618 to 1.00 (or 1.00 to 0.618 for they are the same ratio), was extensively and consciously used by Robert and his brother and can now be detected?

The exploration of these questions and a more complete discussion of the Golden Section must be undertaken next.

II — A POSSIBLE BASIS FOR ADAM PROPORTIONS

In the previous section I have looked at the aims of Robert and James as stated in their great manifesto *The Works in Architecture* or deduced from their lives. I have been able to find clear evidence that Robert, at least, studied geometry; that he used geometric devices such as the 'first conchoid curve' in his architecture deliberately, at a time when most architects merely called it 'the method of the ancients' to produce entasis, if they thought of it at all. Certainly, he deliberately avoided a rule-of-thumb geometry which was perhaps one way to induce the feeling of 'movement' into his rooms or buildings. The questions that now emerge are these: Why are Adam proportions so distinctive? Is there any discernible system in the design of Adam façades or interiors? If so, did Robert Adam *deliberately* use a special kind of geometry, a non-Palladian system of proportions in this work, or did some system appear in his designs merely by chance or because he had a natural eye for 'good taste'? I maintain that the former is likely, on the premise that most great artists, and particularly architects, are generally aware of patterns that lie beneath the surface of their art.

12 J. Hambridge, *Dynamic Symmetry* (New Haven, Yale University Press, 1920); P.H. Scofield, *Theory of Proportion in Architecture* (Cambridge, Cambridge University Press, 1958).

13 The diagonals drawn upon Figs. 4 and 6 are done using Manning Robertson's 'golden' set-squares (cf. n. 16).

14 Wittkower, *Architectural Principles...*

How does one go about probing this question? Rectangles exist in the façades of all Adam buildings, or can be induced in the mind of the beholder, but were their proportions deliberately designed by the master to any recognizable basic form? Fortunately Rudolf Wittkower has already shown how to attack this problem in his study of the mathema underlying the works of Leon Battista Alberti and Andrea Palladio. He claimed that there were two 'proofs' acceptable to him; either that the architect explicitly stated his principles in writing, which Adam never did for façades or interiors, or that he showed by actual dimensions on his drawing what system was in his mind. Wittkower pointed out¹⁴ that workmen built partly by *their* own interpretation of stone or space, so that measuring a building is itself no proof of the certain intent of the designer. Further, drawings up to 1700 or so were not necessarily drawn to accurate scale. Therefore, neither early drawings nor prints could be measured to obtain proof of precise proportions. But this restriction no longer applies to Adam plans or elevations. By 1760 a well-organized draughting office would certainly work their drawings accurately to scale. The Adam drawings usually show the scale clearly on them. Therefore careful measurements of these drawings should be worthwhile to indicate deliberate intent: if a geometric system were to underlie Adam designs, it should appear frequently and with reasonable precision as far as the best measurements will allow us to tell.

I have examined the original Adam papers in a number of ways. First of all I have searched the freehand sketches for visual indications of geometric construction such as compass marks or projections of diagonals. There are in Sir John Soane's Museum in London eleven volumes of Adam pencil sketches or rough drawings. They show explorations by mind and pencil, untrammelled by restraints of formality, but sensitive to them and to geometry. The occurrence of squares and rectangles is, of course, frequent. Roughly, the rectangles often have sides in the proportion of 3 to 5 or 5 to 8. Squares plus rectangles also give larger rectangles whose sides lie in the ratio of 3:5, 5:8, or 8:13, that is, ratios of breadth to length of between 1:1.67 and 1:1.60. These occur very frequently; the ratios 1:2 or 2:3 rather seldom.

There are no indications in these sketches that any single system was intended. Nor are there indications that a geometrically precise computation was used, either by formalized constructions with compass and ruler, by the clear use of diagonals or by regular triangles or pentagons. I must conclude, as Sir John Summerson in his

Architecture in Britain and others before me, that at this stage the designing was done by eye alone. Geometry was used as a device to induce or extend symmetry and proportion was related mainly to what Robert Adams considered to be 'good taste.'

The second way to analyse Adam design has been to measure to the nearest millimetre the façades of buildings in working drawings in the Sir John Soane's Museum as well as the original engravings as published in the *Works* (1773-78 edition). The problem with this technique is where to start each measurement; at ground level or at the start of the main structure above the base. Does one measure to the peak of the roof, the base of the cornice or to its top, to the base of window sills or the top? I have chosen to use the main visual lines of a façade as seen from the ground by an observer. These are usually the base line, the top of a cornice or course of stone dividing stories, the outer edges of buildings, the peak line of the roof, main corners of wings or porticos. While the method has a subjective element in it, at least I have applied my own principles consistently and as objectively as possible.

From an analysis of 35 different buildings designed between 1758 and 1792 I have found that the Adam brothers frequently used proportions based on the numbers 3:5:8:13. These numbers are known as the Fibonacci series, after their discoverer, Amadeo Fibonacci. They have the property that two adjacent numbers add up to make the next ($3 + 5 = 8$, $5 + 8 = 13$, etc.). This is probably why the Adam freehand sketches also contain rectangles whose sides are in proportion to adjacent pairs of this series ($5/3 = 1.67$; $8/5 = 1.60$; $13/8 = 1.625$). Now many of the ratios measured by me, particularly the rectangles in façades, the spacing of legs in tables, the dimensions of rooms, or divisions of wall height, panelling or moulding lines or pilaster positioning, a few important ceilings, seem to have in them the proportion of 1:1.62. This corresponds to the ratio of more advanced terms of Fibonacci's series, 13 to 8, 21 to 13, or any set higher. This proportion approaches the Golden Section 1:1.618 or ϕ (phi).

In Figure 7, I have shown a rectangle, ABCD, whose sides have lengths such that the longer side AB is to the shorter BC as the sum of the two sides AB + BC is to the longer AB, i.e. $\frac{AB}{BC} = \frac{AB + BC}{AB}$. This is then often termed a 'golden' or ϕ rectangle and the sides will have a ratio of their lengths 1.618:1. Such a rectangle has the interesting property that if a square be constructed on its longer side, ABEF, a new, larger, ϕ rectangle CDFE is produced. The number 1.618 is related to Fibonacci's

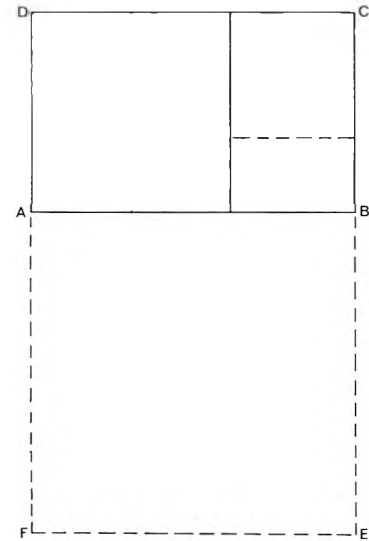

FIGURE 7. Golden rectangles. The rectangle ABCD has its sides in proportion to the 'golden number'.

$$\text{That is } \frac{AB}{AC} = \frac{AB + AC}{AB}$$

$$\text{Also } \frac{AB}{AC} = \frac{\sqrt{5} + 1}{2} = \phi.$$

A large square, ABEF drawn on the side AB makes another 'golden' rectangle CDFE.

series in several ways. For instance $\phi - 1$, 1 , ϕ , $\phi + 1$, $2\phi + 1$ etc. are themselves a kind of Fibonacci's series where the sum of any two adjacent terms makes up the next. Also, the ratio of any two successive terms is itself ϕ or 1.618. That is $1.00 / 0.618 = 1.618 / 1.00 = 2.618 / 1.618$ and so on. Finally, the successive terms of the original Fibonacci series, if used as a ratio, become closer to ϕ the larger the numbers used. It is this geometry, approximating ϕ , which is indicated, though not proven, in so many of the Adam drawings.

In Section 1 of this article I have shown Adam drawings of Kenwood House (Fig. 4) and the British Coffee House (Fig. 6). In each of these, rectangles appear which look rather similar to ϕ rectangles. Measurement confirms this, for the Kenwood façade has rectangles of dimensions which scale $59' \times 36'6'' (= \phi)$ and similarly do the rectangles which make up the British Coffee House. In the latter case I have shown these separately to indicate a possible way the design might have evolved for the façade. The surprisingly close fit of these figures to Golden Sections made me think that this clue was worth pursuing further.

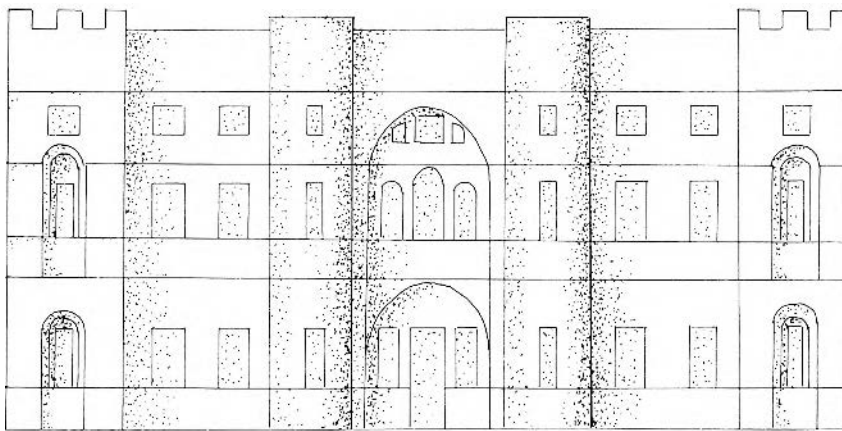
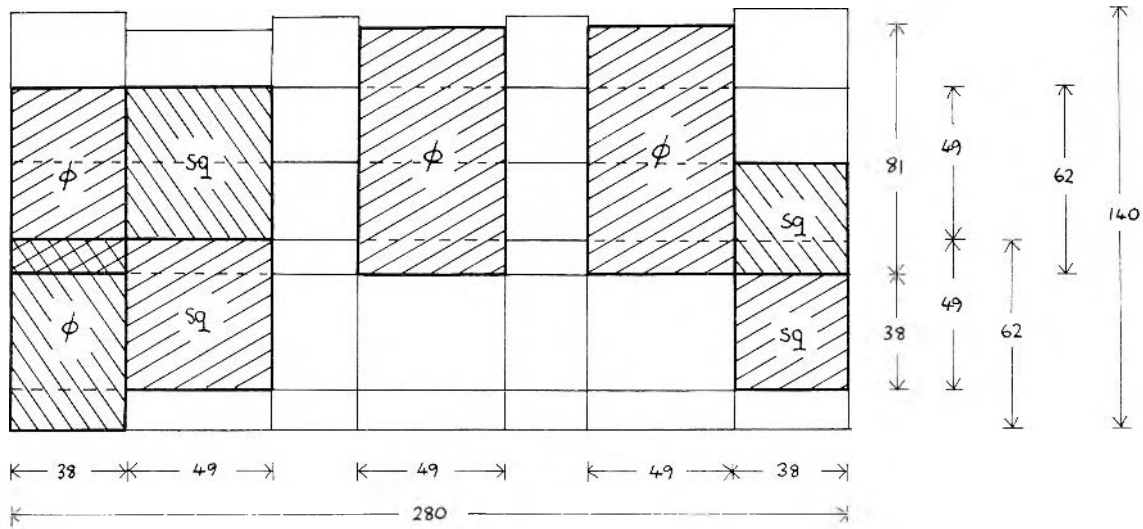

FIGURE 8. Robert and James Adam, *Dalquharran Castle, Ayrshire, ca. 1788* (Drawing: C. Munro).

Of the 35 buildings analysed by the measurement method, I have found 17 obvious examples of rectangles whose sides are in the ratio of the so-called 'irrational numbers', $1:\sqrt{2}$, $1:\sqrt{3}$ and $1:\sqrt{5}$. There were over 110 examples of rectangles with sides with length ratios 1.6 to 1.7. Of these, 77 had the proportions 1:1.62 within 1%,

15 The chi-squared test is used to assess the statistical probability that individual observations (o) are likely to occur scattered at random around some theoretical value (r). Here the theoretical values are ϕ ($= 0.62$), $\phi/2$, $\phi + 1$ etc.

$$\text{chi squared, } X^2 = \frac{\sum (o - r)^2}{r} = \frac{77 (.63 - .62)^2}{.62} + 33 \frac{(.65 - .62)^2}{.62} + \text{etc.}$$

In cases where X^2 is less than unity, as here, a strong bias in selection of sample is indicated. This is exactly what Adam seems to have done for rectangles or proportions between 1:0.57 and 1:0.67.

and another 33 were within 3%. There were also at least 4 cases with close approximation to $1:0.81$ ($= \phi/2$) and ten others to $1:(\phi + 1)$ or $1:(2\phi + 1)$ which are higher terms of the ϕ series. Statistically, this is a very significant finding, for by the well-known 'chi-squared' test it is *most* unlikely to occur by chance alone.¹⁵ Therefore I concluded that Robert and James Adam repeatedly used dimensions which lead to *visual* main divisions of their façades so that the proportions of ϕ or its relatives should occur. This was not at all done routinely or by rule, but continually varied so that some of the main rectangles are horizontal, others vertical, many are overlapping and some are combined with square-root 'irrationals.' But in every drawing there was at least one, usually more than three, visually prominent rectangles closely

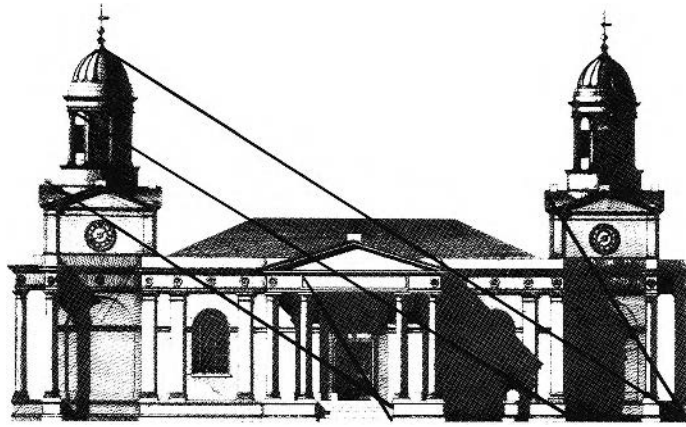

FIGURE 9. Robert and James Adam, *Mistley Church, Essex*, 1776 (from *The Works in Architecture*).

approximating the proportions of the higher members of Fibonacci's series or ϕ . Further, this occurred *after*, but not before Robert's trip to Italy which is itself important. For if a particular system appeared in the Adam façades by accident alone, it should seem to appear in some and not in others without regard to chronology. This is not the case; before Robert went to Italy his two buildings, Dumfries House and the pavilions of Hopetoun were proportioned in simple whole number style, the first using 1:2 and 1:3 (height to width) divisions, the second using 1:4 (cf. Section 1). On the other hand, *all* the façades examined by me from his drawings and engravings done after 1758 show rectangles of non-Palladian types. The main vertical to horizontal visual lines in length are in the proportion of roots of simple numbers, or to the ratio 1.62:1 (that is essentially a Golden Section, ϕ) or both. Further, the use of the ϕ rectangles seem to become more complex and sophisticated with time, so that they appear now horizontally, now vertically, now overlapping, and now in sets. An example of this is shown in The British Coffee House, or in Dalquharran Castle (Fig. 8).

The measurements I have made were my own, and when translated to feet and inches, it was by using the scale drawn on the Adam drawing. Are no complete overall Adam dimensions written onto these drawings? Never, that I could find on façades, though sometimes partial dimensions are given on elevations, particularly of interiors of buildings. However, in a few cases where Adam designed great rooms the floor dimensions appear: the Syon House Entrance Hall (30'4" × 49'3"), the Anterom of Shelbourne

House (21'6" × 35'0"), also the Hall at Kedelston and the Library at Kenwood. These are Adam's figures and are almost exactly 1:1.62 or ϕ . This clear statement of precise proportion does not hold with most of the other plans of 'great rooms.' There was, as usual, continued variation shown in design. But at least for four of his most important clients, Robert Adam used the proportions of the Golden Section, within 1%, and *says so by his own figures*.

The fourth way to analyse building designs for ϕ has been to use the set-squares known as 'Golden Set-Squares,' following the method of Manning Robertson.¹⁶ These instruments are used in drafting offices. Unlike ordinary set-squares whose sides are 1:1 or 1:2 around a right angle, these squares have sides in the ratio 1.618 to 1.00 or 1.618/2 to 1.00. These set-squares, therefore, are ϕ and $\phi/2$, and if lines drawn with them *cross at key visual points*, it is highly likely that the ratio ϕ was used in the basic design.

I have had these set-squares made for me and have used them to draw diagonals of rectangles, vertical as well as horizontal, on copies of the Adam plans. In a surprising number of cases these diagonals cross vertical or horizontal lines precisely at key corners. Alternatively a set of ϕ or $\phi/2$ diagonals may meet at centres of façades, peaks of domes or other important points of design. Examples of this are shown in Figures 9 and 10. Mistley church (Fig. 9) has key intersecting points at the dome, at the portico, at the wings – everywhere are

16 Manning Robertson, 'The Golden Section or Golden Cut,' *RIBA Journal* 11/1.V (1948), 536-543.

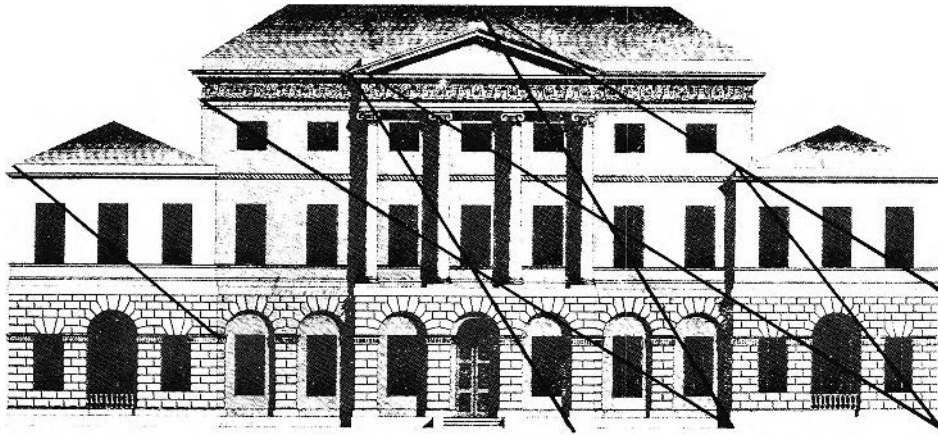

FIGURE 10a. Robert and James Adam, *Shelbourne House, London, 1765* (from *The Works in Architecture*).

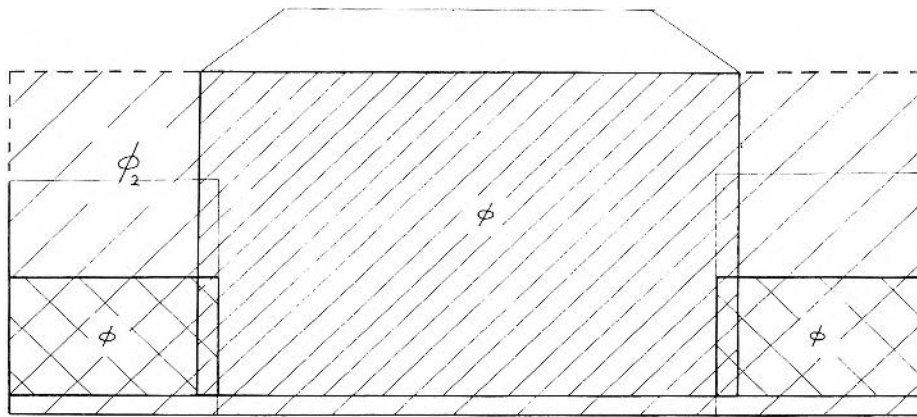

FIGURE 10b. *Shelbourne House* (Drawing: C. Munro).

ϕ or $\phi/2$ rectangles. Shelbourne House (Fig. 10a) is more complex, but here again the intersections occur. Design was possibly done in the manner suggested by the drawing in Figure 10b. This method of Robertson's set-squares can more readily be checked by other people than can my scale measurements. Therefore I think it to be the more objective test of my conclusions. Of course it is difficult to discriminate between ϕ , the Golden Section, and a ratio of, say, 13:8 (a higher set of Fibonacci's series) as Fischler¹⁷ points out. This I do not attempt to do, for to me they are visually and essentially the same.¹⁸

17 Roger Fischler, 'On the Application of the Golden Ratio in the Visual Arts,' *Leonardo*, xiv (1981), 31.

18 David Fenson, 'The Golden Section and Human Evolution,' *Leonardo*, xiv (1981), 232-233.

19 William Adam, *Vitruvius Scoticus* (Edinburgh, Paul Harris, 1980).

20 If any rectangle with unequal sides has a square added to the longer side a new rectangle is formed with its sides closer to a golden rectangle than the first. Thus few repetitions of this process will produce ϕ rectangles, starting by chance alone.

In my opinion, the 'golden' set-squares offer the simplest and best method of checking a design to detect the use of ϕ or close relatives. As Fischler says, for most visual cases the ratio 1:1.618 is indistinguishable from 5:8, that is 1:1.6, yet the golden set-squares easily disclose the difference on a 25cm (or 10") drawing. What about other contemporary designs? In *Vitruvius Scoticus*, collected by William Adam around 1730-48 but not published until 1812,¹⁹ I have been able to use these set-squares to see if ϕ rectangles occur in the façades drawn there. Most often they do not. Only in a very few instances, in the façade of Hamilton Palace, are one or two golden rectangles likely to exist ... possibly by chance.²⁰ Robertson's golden set-square technique confirms my contention that the designs of Robert and James Adam differed from those of their father and his contemporaries in this basic aspect of geometry. Yet for Robert Adam I would say that the golden section represented a design *preference* rather than a guiding principle, for other related proportions such as

those of Fibonacci series were often employed – as were also $\sqrt{2}$, $\sqrt{3}$ etc.

The ϕ rectangles have been called the rectangles of the ‘revolving square,’ because of their relation to eye movement or ‘dynamic symmetry.’²¹ Perhaps Adam felt that their use contributed to the feeling of movement when they were observed, and not merely to good proportion as it appeared to his eye. To my mind, overlapping rectangles of the kind used at Dalquharran (Fig. 8) often induce a type of eye alteration giving the illusion of motion, just as Picasso’s use of two sets of eyes on a painting induces a similar illusion.

Most of the Adam drawings do have dimensions indicated on them as well as scale. But usually when this is done, there are small gaps left between stories for floor-ceiling spaces. These still may be measured from the scale and the dimensions then indicate that ϕ proportions were generally favoured. The effect of leaving gaps in dimensions, while not reducing the precision of the drawing for anyone who cared to measure it by scale, reduces the obvious detection of a recurrent proportion. Thus, *never* is the golden section ratio accentuated so that its *derivation* is completely obvious. Perhaps it was still considered esoteric in the eighteenth century.²² What is it that gives an Adam elevation its peculiar, its distinctive character? Is it the juxtaposition of Adamesque elements, anthemion, light classical motifs etc., a vocabulary which many could imitate, or is it a specific system of proportions which the brothers preferred, their syntax so to speak, less accessible and therefore less vulnerable to the dangers of imitation? As we have seen, none of Robert’s sketches show that he was using a particular geometry. I have found no tables of Fibonacci numbers or ratios indicating ϕ in his letters or notes. Nor have I found evidence for golden set-squares, the most likely device (I think) to give to draughtsmen in the office so that they might translate his rough sketches into finished plans incorporating these proportions. For the ratio 1.62 and its relatives appear so often in the finished drawings that I conclude that Adam employed draughtsmen who at least tended to work to these proportions.

The ϕ ratio also occurs in the Adam interiors which anybody can check by using golden set-squares on elevations of rooms shown in the *Works of Architecture*. For example at Syon House, the entrance hall, the library and the anteroom are all subdivided, subtly, to incorporate this ratio. In Figure 11, I have reproduced Robert Adam’s design for one wall of the anteroom, on which the diagonals of ϕ rectangles have been superim-



FIGURE 11. Robert and James Adam, *Syon House*, London, 1761 (Engraving by G.B. Piranesi from *The Works in Architecture*).

posed. This design was engraved for Robert by his famous Roman friend Giovanni Battista Piranesi. In the lower right-hand corner is a small rectangle with a diagonal across it. This is, at first glance, the shadow in a fireplace of the end wall. The ‘shadow’ proportions are 1:1.62, like a golden set-square in miniature, whereas other shadow angles in the same room are clearly different. I suggest that Piranesi’s ‘shadow’ was a special sign or private joke shared between the engraver and his friend Robert.²³ Certainly Piranesi used visual approximations to ϕ in his own famous drawings of the *Carceri*.²⁴ One might go so far as to suppose that Piranesi was the one to introduce Robert to ϕ in Rome.

In addition to the change in geometry of façades or of interior decoration before and after the Rome visit, a similar change in style can be noted whenever Robert redesigned a pre-existing house. Such changes were planned for Yester House, Mistle and Blackadder, in each case the house appeared to incorporate simple whole number ratios before, but not after his proposals were set on paper. The new designs incorporate simple

21 See Hambridge, *Dynamic Symmetry*.

22 See Scofield, *Theory of Proportion...*; and Robertson.

23 Scale measurements of the plans and elevation of Syon House Anteroom (*Works*, II, n° IV, pl. VI and VII) show that the fireplace design was here thirty inches deep, much deeper than usual fireplaces or any other fireplace at Syon. Moreover the elevation shows that this Anteroom fireplace was forty-five inches high, whereas Piranesi’s engraving measures about 48½ inches. Therefore it seems likely that Piranesi distorted the original facts to obtain his miniature golden set-square ‘shadow.’

24 *Giovanni Battista Piranesi. Drawings and Etchings at Columbia University* (Low Memorial Library, 21 March – 14 April 1972).

roots (like $\sqrt{2}$ or $\sqrt{3}$ or $\sqrt{5}$) and ϕ rectangles in them, none of which are strictly Palladian in origin.

There is another way in which the deliberate use of this geometry can be indicated. If a set of proportions is taken, say the cornice height (i.e. to the top of the cornice, because it is the visual line caught by the eye) and the width of a building, this set leads to a certain number ratio. If now all the other main divisions of the façade can be arrived at by simple and logical steps, either dividing by small whole numbers, or by their roots, or by the numbers of the ϕ series, it clearly suggests that these simple integers or ϕ terms were intentionally used in the planning (e.g. Shelbourne House, Fig. 10). This indeed seems to be the case in the Adam drawings. It is this step-by-step game which has convinced me most forcibly that deliberate intent played its part. To start with a simple ratio of whole numbers is one thing, but to progress by steps to the other main proportions all around the building and to find recurrent use of the ϕ rectangles, often of an advanced number of the ϕ series, like 2.618 or 4.236 to 1, seems impossible by chance alone (Figs. 8, 9 and 10). Other examples are found in the designs of the Old College, Edinburgh University or of Register House, Edinburgh.

Nor did Adam confine himself to rectangles alone. In Sir W. Watkin-Wynn's house (Fig. 12), at 20, St. James Square, London, he used ϕ to obtain vertical divisions of height, one set based on the overall height, another on a sub-unit of this. The rectangles, other than a set of windows, are not ϕ rectangles, they are $\phi/2$. But the overall proportions remain very much the proportions of the Golden Section (i.e. ϕ).

We know from Robert's letters in the Penicuik papers that he was concerned with precise measurements, for he wrote to John and James from Rome, asking for a volume of Desgodetz,²⁵ since he thought his own measurements of Roman buildings were more accurate. We know also that his reconstruction of the Palace of Diocletian at Spalatro involved precise measurements²⁶ and in some of these Robert's measurements indicate ϕ rectangles.

We know that ϕ , the Golden Section, and its properties were rediscovered by Pacioli around 1495 and that the rediscovery was published in

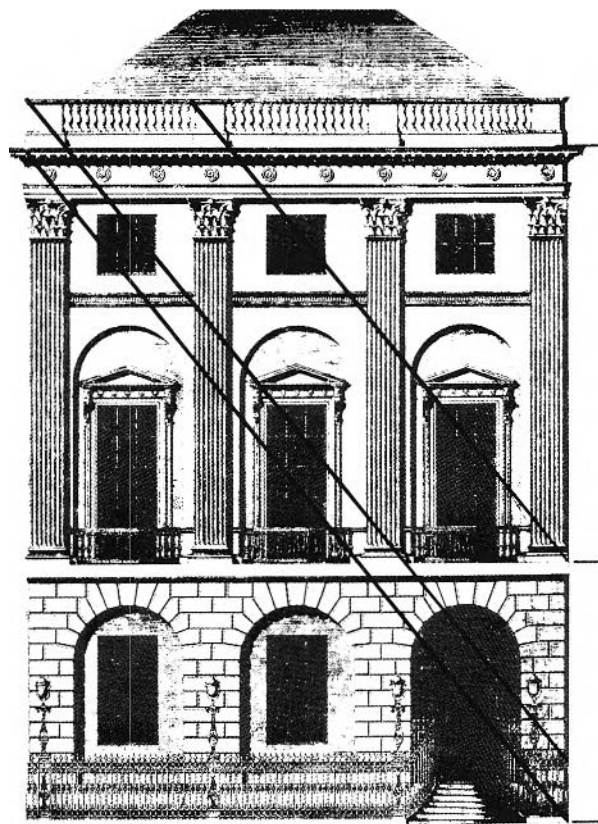

FIGURE 12. Robert and James Adam, *Sir Robert Watkin-Wynne's House, London, 1772* (from *The Works in Architecture*).

1509 and illustrated by Leonardo da Vinci. Leonardo never seems actually to have built an edifice using ϕ , though he, Botticelli, Raphael and others possibly used the proportions in their paintings, according to Cook.²⁷ But Bramante, Raphael and Michelangelo knew about Pacioli's book and may have used the proportions both subconsciously and consciously when it suited them. If the use of the Golden Section were still secret in the eighteenth century, as seems to me to be likely, then this shared secret may have been one of the reasons for the mutual friendship of G.B. Piranesi and Robert Adam.

Like Michelangelo, Robert Adam did not use any scheme slavishly, but only when it suited him. So too, with his use of 1:1.62 proportions.

To recapitulate, the question of whether Adam used ϕ or 13:8 proportions deliberately would seem to be answered as very likely. He does not state this categorically, nor do his rough sketches give proof of its derivation. Yet his known interest in geometry, his known concern with precise measurements, the use of ϕ rectangles in façades,

²⁵ John Fleming, *Robert Adam and His Circle* (London, John Murray, 1962).

²⁶ Robert Adam, *Ruins of the Palace of the Emperor Diocletian at Spalatro in Dalmatia* (London, 1764).

²⁷ Theodore Cook, *The Curves of Life* (London, Constable, 1914).

walls, the dimensions of important rooms, and furniture designed after his visit to Rome (not before), the very close scale measurements obtained from his many surviving drawings, the actual façade or room dimensions given in some cases, the progressive complexity of the use of the ϕ series which appears as he grows older, and the impossibility of proceeding step-wise in design around a building so that members of the ϕ series occur and recur, without deliberate intent, all these arguments force the conclusion that Robert and James did use geometrical schemata and did introduce the mathema of the Fibonacci series, root ratios (irrational numbers) and probably the Golden Section deliberately into their plans.

Was Robert Adam the first to reintroduce these proportions into neo-classical architecture in Britain? Robertson argues that Sir Christopher Wren occasionally used the ϕ proportion because he had a fondness for squares. Sir William Chambers (who had also studied in Rome) occasionally used it, and seems to have used it quite deliberately,²⁸ and then subdivided this space in terms of modules. But while Chambers may have designed some buildings in 'the Adam Style,' at most times he is known to have made designs 'deliberately Spartan' to avoid suggestions of Adam influence.²⁹ In the few cases where ϕ rectangles appear in *Vitruvius Scoticus* they may then have occurred by chance.

Adam's first building, the Admiralty Screen, seems to have been designed about the Golden Section and built in 1760. From then on he used ϕ proportions repeatedly, though not slavishly. I

must conclude that while Robert Adam was not the first to use the Golden Section in English classical revival building, he may have been the first to use irrational numbers (that is $\sqrt{2}$, $\sqrt{3}$, $\sqrt{5}$), and the Fibonacci and ϕ series deliberately and constantly – but with continued variations – in almost all designs after 1758. If so, his contemporaries and rivals would have been eager to pick up the clues – if they did not already have them. Wittkower³⁰ thought that Golden Section designs in architecture – other than those used in Mediaeval Gothic – were not introduced until the mid-nineteenth century. This now seems incorrect: Chambers occasionally used them, so did Robert Hooke³¹ and Wren,³² and Adam almost always did. It does seem as if Adam systematically introduced this form into his neo-classical style, and was the first to do this in an extensive manner in Britain. Le Corbusier in this century has also extensively based his design on this system.³³ The difference is that Le Corbusier talked about it, Adam did not.

28 For example in the Casina erected at Marino, Clontarf, outside Dublin (designed before 1759, built 1769).

29 James Lees-Milne, *The Age of Adam* (London, Batsford, 1947); John Harris, *Sir William Chambers* (London, Zwemmer, 1970).

30 Rudolf Wittkower, 'The Changing Concepts of Proportion,' *Daedalus*, LXXXIX (1960), 194-212.

31 Margaret I. Espinasse, *Robert Hooke* (Berkeley / Los Angeles, University of California Press, 1962).

32 Scofield, *Theory of Proportion...*

33 Roger Fischler, 'The Early Relationship of Le Corbusier to the Golden Number,' *Environment and Planning B*, vi (1979), 95-103.

RÉSUMÉ

En 1758, le brillant architecte écossais Robert Adam (1728-1792) retourne en Grande-Bretagne au terme de ses voyages en Europe et s'installe à Londres. Il ramenait des croquis, plans, projets de décorations, et des artisans italiens qui l'aidèrent à instaurer une sorte de révolution néo-classique dans l'architecture anglaise du XVIII^e siècle. Aujourd'hui un bâtiment Adam accroche toujours l'attention par son élégance et son style particulier. Néanmoins, l'essentiel de ce style demeure difficile à préciser. L'auteur de cet article explore l'hypothèse du principe de géométrie unique qui aurait soutenu les rapports de proportions donnés par Robert et par son frère James au design des façades et des pièces intérieures de leurs bâtiments. Il semble en effet plus que probable qu'ils aient employé la section dorée de façon délibérée dans un nombre considérable de dessins. On sait que Robert Adam étudia la géométrie à l'université. Mais il employa aussi vraisemblablement la courbe conchoïdale pour donner une force expressive à son architecture; c'est donc dire qu'il aurait utilisé intentionnellement un système de proportions non palladien dans un style néo-classique. Ce système intègre au design architectural les nombres irrationnels, en particulier la suite de Fibonacci dont les éléments se rapprochent de la section dorée et de ses nombres relatifs. Il semble que cette géométrie ait été adoptée par Adam au retour de son séjour à Rome de 1754-1758, et qu'il ait partagé ce secret de composition avec G.B. Piranesi, à une époque où peu d'architectes comprenaient son impact.
