

Soil and Ground-water Remediation Techniques

Raven Beck

Volume 23, Number 1, March 1996

URI: https://id.erudit.org/iderudit/geocan23_1ser03

[See table of contents](#)

Publisher(s)

The Geological Association of Canada

ISSN

0315-0941 (print)

1911-4850 (digital)

[Explore this journal](#)

Cite this article

Beck, R. (1996). Soil and Ground-water Remediation Techniques. *Geoscience Canada*, 23(1), 22–40.

Article abstract

Urban areas typically contain numerous sites underlain by soils or ground waters which are contaminated to levels that exceed clean-up guidelines and are hazardous to public health. Contamination most commonly results from the disposal, careless use and spillage of chemicals, or the historic importation of contaminated fill on to properties under-going redevelopment. Contaminants of concern in soil and ground water include: inorganic chemicals such as heavy metals, radio active metals, salt and inorganic pesticides, and a range of organic chemicals included within petroleum fuels, coal tar products, PC Boils, chlorinated solvents, and pesti-cides. Dealing with contaminated sites is a major problem affecting all urbanareas and a wide range of different remedial technologies are available. This chapter reviews the more commonly used methods for ground-water and soil remediation, paying particular regard to efficiency and applicability of specific treatments to different site conditions.

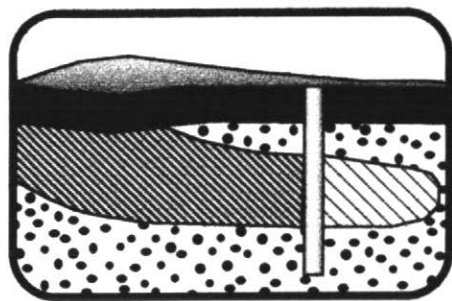

Soil and Ground-water Remediation Techniques

Paul Beck
Raven Beck Environmental Ltd.
 7500 Woodbine Avenue, Suite 201
 Markham, Ontario L3R 1A8

SUMMARY

Urban areas typically contain numerous sites underlain by soils or ground waters which are contaminated to levels that exceed clean-up guidelines and are hazardous to public health. Contamination most commonly results from the disposal, careless use and spillage of chemicals, or the historic importation of contaminated fill onto properties undergoing redevelopment. Contaminants of concern in soil and ground water include: inorganic chemicals such as heavy metals, radioactive metals, salt and inorganic pesticides, and a range of organic chemicals included within petroleum fuels, coal tar products, PCB oils, chlorinated solvents, and pesticides. Dealing with contaminated sites is a major problem affecting all urban areas and a wide range of different remedial technologies are available. This chapter reviews the more commonly used methods for ground-water and soil remediation, paying particular regard to efficiency and applicability of specific treatments to different site conditions.

RÉSUMÉ

Il arrive fréquemment que les zones urbaines soient situées en des endroits dont le sol et les eaux souterraines soient pollués à des niveaux dépassant les normes prescrites et qui présentent des risques pour la santé publique. Le plus souvent, la contamination est le résultat de l'enfouissement, d'une utilisation négligente et de déversements de produits chimiques, ou de l'utilisa-

tion de matériaux de remplissage contaminés à des fins de terrassement lors de travaux de rénovation urbaines. Les contaminants les plus inquiétants dans les sols et les eaux souterraines comprennent les composés inorganiques tels les métaux lourds, les métaux radioactifs, les sels et les pesticides organiques, et une gamme de produits organiques accompagnant les combustibles pétroliers, des dérivés du goudron de houille, des huiles à BPC, des solvants chlorés, et des pesticides. La question des terrains contaminés est un problème majeur affectant toutes les zones urbaines, et il faut savoir qu'il existe toute une panoplie de technologies de restauration. Dans ce chapitre, on examine les méthodes les plus employées pour la restauration des eaux souterraines et des sols, en portant une attention particulière à l'efficacité et l'applicabilité de chaque traitement en fonction des caractéristiques des différents terrains.

INTRODUCTION

The built landscapes of urban areas are widely characterized by contaminated substrates and ground waters. A recurring theme throughout this volume has been the need to identify sources of chemical contamination and characterize the extent of contamination in the subsurface. In general, the impact of contaminants on the environment depends on the physical characteristics of the contaminated site, the toxicity and mobility of the contaminant, and the geometry of the contaminant source.

The need for clean-up of soil and ground water is frequently triggered either by complaints from adjacent prop-

erty owners, who are affected by off-site migration of contaminants, or by the sale and/or redevelopment of contaminated properties. Site investigations prior to property transactions are now routine. A wide range of clean-up options is available, and great care is needed in choosing the most appropriate technology.

The recent development of remedial technologies for the treatment of soil and ground water has been greatly influenced by the environmental threat increasingly presented by organic chemicals known as non-aqueous phase liquids (NAPLs). NAPLs are organic liquids which have a low solubility in water, but their solubility is often significantly greater than drinking-water clean-up criteria (e.g., Feenstra, in press; François and Molyneux, in press). NAPLs can be less dense than water (LNAPLs) including such liquids as fuels and light oils, or more dense than water (DNAPLs) including chlorinated solvents and coal tars. Soil and ground-water contamination involving NAPLs often results from the leakage of underground storage tanks or spillage at surface during handling and transfer operations.

The release of a large volume of LNAPL from an underground storage tank (Fig. 1) results in downward movement of LNAPL through the unsaturated zone toward the water table under the influence of gravity and capillary action, leaving residually saturated LNAPL in the unsaturated zone. The capillary fringe and the water table provide a barrier to further downward migration of the LNAPL. LNAPL accumulates as free product spreading horizontally on top of

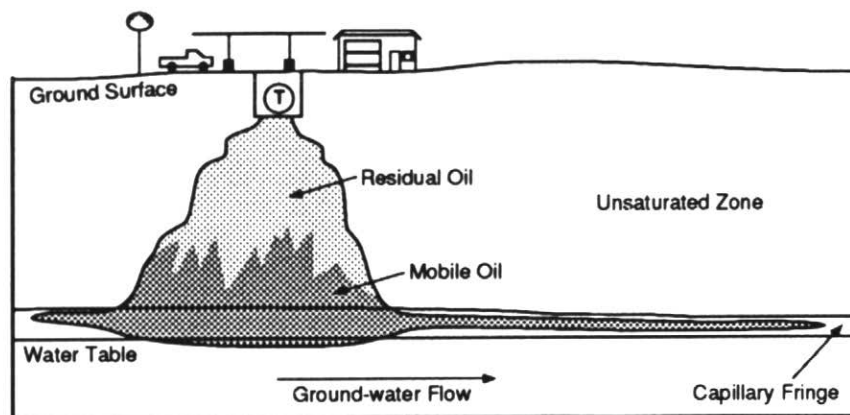

Figure 1 Migration of spilled LNAPL in subsurface resulting from sudden large volume loss from underground storage tank (T). See also Chapter 7.

the water table. A plume of dissolved phase LNAPL develops in ground water and moves in the direction of ground-water flow.

Leakage of DNAPL from an underground storage tank is depicted in Figure 2. DNAPL moves under the influence of gravity through the unsaturated zone to the water table. Because it has a density greater than water, DNAPL migrates across and below the water table until it reaches a low-permeability base or horizon, where it will accumulate and migrate laterally. A plume of dissolved phase DNAPL migrates in the direction of ground-water flow. A detailed discussion of the subsurface controls affecting DNAPL migration is provided by Feenstra, *in press*.

The distribution of contaminants resulting from surface or near-surface spills can be extremely complex. As a result, the methods and strategies used to remediate contaminated soil and ground water vary according to the nature and distribution of contaminants. An important consideration is that contamination commonly involves mixtures of different contaminants including metals and organics in soil, *versus* metals alone; or where the same contaminant such as gasoline occurs in both the soil above the water table and in ground water. Consequently, at complex sites, it is unlikely that a single treatment train

will be suitable for clean-up; several different processes may be required.

Classification of Treatment Technologies

Treatment technologies can be broadly classified as either 1) isolation methods, 2) separation methods, or 3) destructive methods.

Isolation is a form of contaminant treatment/management that physically isolates and contains the contaminant from the environment; the purpose of isolation is to decrease further spread of the contaminant within the environment, or to reduce exposure to human or environmental receptors. Barrier walls are an example of an isolation method.

Separation methods involve physical and/or chemical processes which separate contaminants from the matrix, leaving a clean matrix and a contaminant concentrate which requires further treatment. Soil-washing and filtration processes are examples of separation methods.

Destructive methods apply only to organic compounds, and involve chemical or biological processes which cause a change in the chemical structure of the contaminant to transform the compound into non-toxic by-products. Examples of destructive technologies include bioremediation and incineration.

However, both of these technologies can, in some cases, produce by-products that are more toxic than the original contaminant. For example, incomplete biodegradation of trichloroethylene can produce the highly toxic intermediate vinyl chloride. Incineration of PCBs at too low a temperature can produce 2,3,7,8-tetrachlorodibenzo-p-dioxin (TCDD).

Treatment technologies can also be classified according to the dominant treatment process as thermal, physical, chemical or biological. Some technologies can be operated on site without removing soil or ground water. These methods are termed *in situ* methods. Other technologies require excavation of soil or pumping of ground water and treatment on surface or off site. These methods are termed *ex situ* methods.

A list of treatment technologies that will be discussed later in the paper is provided in Table 1.

Status of Treatment Technologies

The field of ground-water and soil treatment technologies is a dynamic one, constantly undergoing change as existing technologies are improved and new ones emerge. Because the field is relatively new, and because of the high costs associated with treatment and monitoring, there are very few technologies that have undergone rigorous testing under a variety of conditions for a variety of contaminants. Consequently, there may be no history of performance for a vendor technology under a given set of conditions. It is therefore necessary, prior to the application of a technology for full-scale clean-up, that some pilot testing or field testing over a small area of the site, or the testing of a large (several kilograms to several tonnes) sample size taken from the site, be conducted first to establish appropriate operating parameters of the technology, and to provide a reasonable estimate of full-scale clean-up costs. Emerging technologies which show promise at the laboratory scale may not be capable of completing full-scale clean-up.

Several major government-funded programs in the United States and Canada have provided support for the demonstration of soil/sediment and ground-water treatment technologies. These include: 1) U.S. EPA SITE Program (evaluation of innovative technologies for the

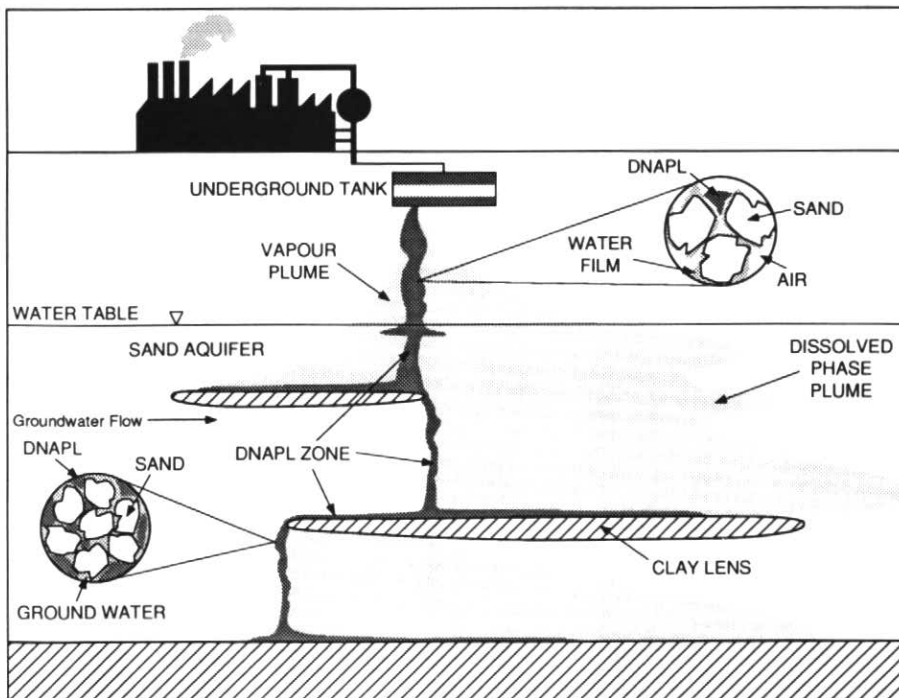

Figure 2 Migration of leaking DNAPL in the subsurface. See also Chapter 6.

Table 1 Summary of treatment technologies/management methods described in text.

SOIL

| | TREATMENT TECHNOLOGY | TYPE | MAJOR PROCESS | CONTAMINANTS AFFECTED |
|-----|------------------------------------|-----------------------------|----------------------|----------------------------------|
| 1. | Incineration | destructive | thermal | organics |
| 2. | Low Temperature Thermal Desorption | separation | thermal | volatile, semi-volatile organics |
| 3. | Solidification/Stabilization | isolation | physical | inorganics, (organics?) |
| 4. | Soil Washing | separation | physical | inorganics, organics |
| 5. | Solvent Extraction | separation | chemical | inorganics, organics |
| 6. | Reduction-oxidation | destructive | chemical | organic |
| 7. | Bioremediation | destructive, immobilization | biological, physical | organic metals |
| 8. | Soil Vapour Extraction | separation | physical | volatile organics |
| 9. | Excavation/Landfilling | separation, isolation | physical | inorganics, organics |
| 10. | Steam Extraction | separation | physical | inorganics |
| 11. | Hydraulic Fracturing | n/a | physical | improve permeability |
| 12. | Naturalization | isolation, destructive | physical/biological | organics |

GROUNDWATER

| | TREATMENT TECHNOLOGY | TYPE | MAJOR PROCESS | CONTAMINANTS AFFECTED |
|-----|--|--|---|---|
| 1. | Hydraulic Fracturing | n/a | physical | improve permeability |
| 2. | Free Product Recovery | separation | physical | NAPLs |
| 3. | Groundwater Pump and Treat granular activated carbon filtration air stripping advanced oxidation bioreactors | separation separation separation destructive destructive | physical/chemical physical physical physical biological | organics, inorganics organics, inorganics volatile organics organics organics |
| 4. | Chemical Treatment | separation | physical/chemical | inorganics, organics |
| 5. | Chemical Washing | separation | chemical | organics, inorganics |
| 6. | Bioremediation | destructive | biological | organics |
| 7. | Air Sparging | separation, destructive | physical | organics |
| 8. | Reactive Walls | destructive | chemical | organics |
| 9. | Manufactured Wetlands | separation, destructive | physical/chemical | inorganics, organics |
| 10. | Isolation | isolation | physical | inorganics, organics |

clean-up of Superfund sites in the United States); 2) Environment Canada and Provinces DESRT Program (evaluation of technologies to clean up contaminated sites in Canada); 3) Environment Canada and Provinces COSTTEP (evaluation of contaminated sediment treatment technologies in Canada); and 4) Ontario Ministry of the Environment and Energy (OMOEE) Environmental Technologies Program (ETP) (promotion and development of environmental

technologies in Ontario).

The U.S. EPA SITE Program was established to support the demonstration of innovative technologies that provide alternatives to existing established technologies and landfilling. Innovative technologies are those technologies for which cost and performance data is limited, while established technologies are those which have a history of use, and consequently performance and costs are well documented. The United

States Environmental Protection Agency considers incineration, solidification/stabilization, and soil aeration as established technologies. The distribution for the application of 666 technologies to Superfund sites through fiscal year 1993 is shown in Figure 3. Clean-up plans for 56% of the sites involved established technologies, the majority of which involved incineration and solidification/stabilization. The remaining 44% of site clean-up plans involved innovative technologies such as soil vapour extraction, bioremediation and thermal desorption. Soil vapour extraction accounts for more than two-thirds of soil treatment, with most of the remaining treatment being completed by *in situ* soil flushing, thermal desorption, *in situ* bioremediation, and soil washing.

The Development and Demonstration of Site Remediation Technology Program (DESRT) was established under the National Contaminated Sites Remediation Program through the federal-provincial-territorial Canadian Council of Ministers of the Environment. Thirty-four demonstration projects were funded. Thirty of the 34 involved soil treatment technologies, of which 50% involved bioremediation. A summary of DESRT Program demonstration projects is shown graphically in Figure 4.

The Contaminated Sediment Treatment Technology Program was initiated by Environment Canada under the Great Lakes Action Plan to assess re-

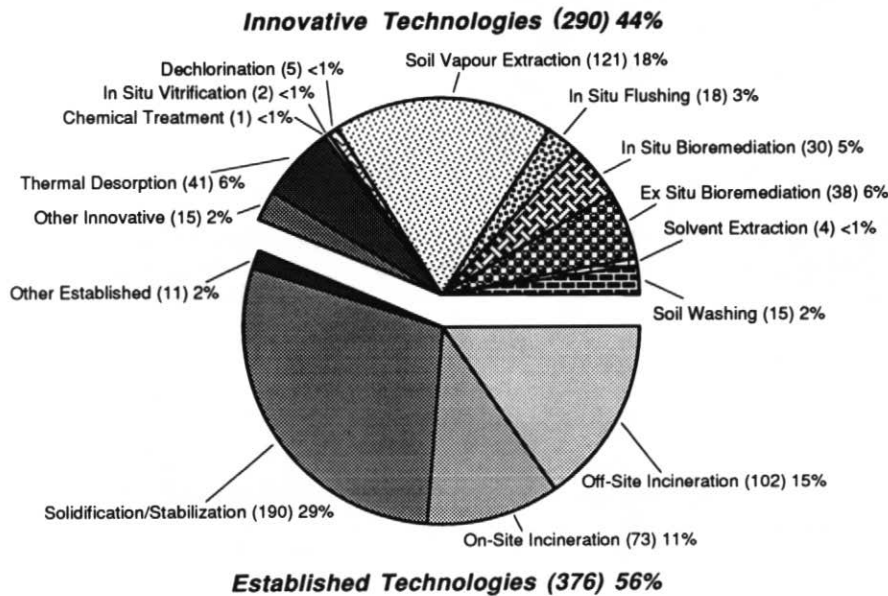

Figure 3 United States Superfund remedial actions: summary of alternative treatment technologies from 1982 to 1993. Numbers in parentheses identify number of times that technology was used; more than one technology is commonly used at any one site.

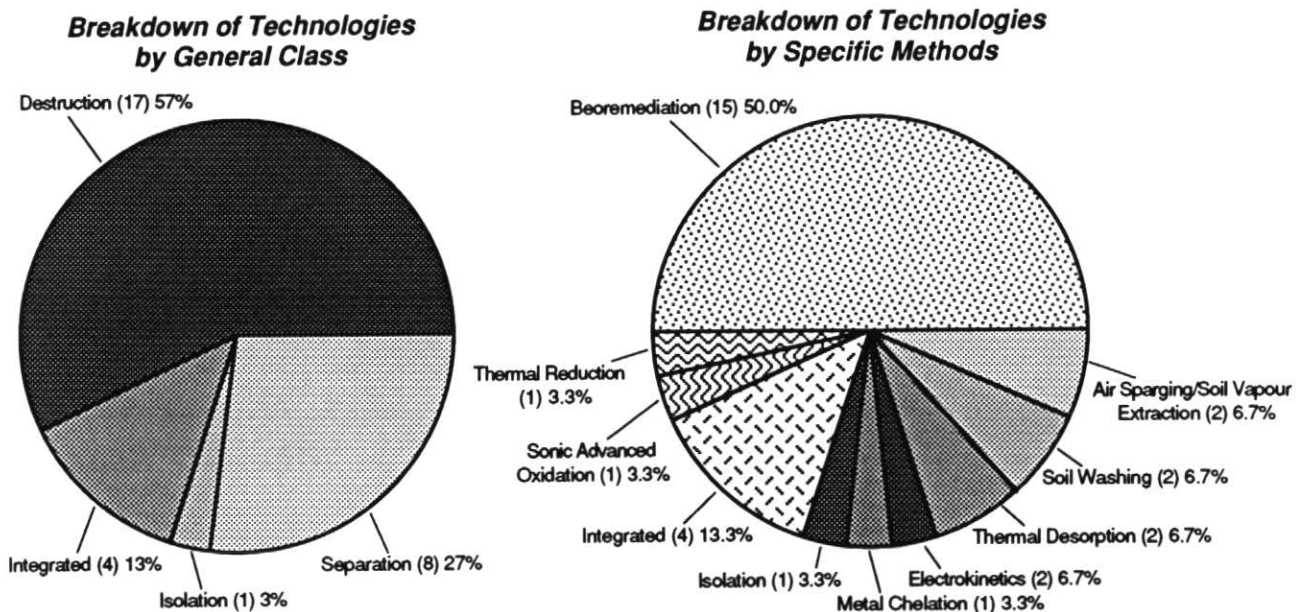

Figure 4 Summary of treatment technologies funded by DESRT Program in Canada.

medial technologies at bench, pilot and full scale in support of efforts to clean up 17 Areas of Concern around the Great Lakes (see Coakley and Mudroch, in press). Four of the eighteen projects were conducted at pilot scale, with the remainder at bench scale.

The OMOEE ETP was implemented to assist Ontario-based technology vendors in the development and commercialization of environmental technologies, with particular emphasis on technologies that had the potential to be marketed internationally (OMOEE, 1994).

TREATMENT TECHNOLOGIES

As discussed previously, some contaminant situations may require multiple or integrated treatment trains, but, for the purposes of this discussion, we will describe individual technologies under separate headings for soil and ground water.

Soil Remediation Technologies

Incineration

Incineration is a well-developed *ex situ* technology that is suitable for destruction of organic compounds. Complete combustion is controlled by the incineration temperature, the residence time of the contaminant in the burner, the availability of oxygen, and the physical and chemical characteristics of the waste streams. Incinerator designs include rotary kilns, fluidized-bed and circulating-bed combustors, plasma arc, and infra-red. They can be stationary facilities or track-mounted. In a rotary kiln, waste is conveyed to a rotating chamber and incinerated at temperatures ranging from 800° to 1500 °C. A secondary combustion chamber may be required to ensure combustion of gases generated in the primary kiln. Incinerators should operate under high combustion efficiencies to prevent the formation of products of incomplete combustion (PICs) which are highly toxic. A schematic for a rotary kiln is shown in Figure 5.

Low Temperature Thermal Desorption

Thermal desorption is an *ex situ* separation technology that applies heat to soil to separate volatile and semi-volatile organic compounds from the soil matrix. The heated contaminant airstream is directed to a second process unit where

the contaminants are destroyed by thermal or catalytic oxidation to carbon dioxide and water, or are separated by adsorption onto activated carbon.

The technology can be fixed or transportable. It is particularly suited to the treatment of gasoline and petroleum fuels. Treatment costs for dry sandy soils are competitive with landfilling. Increased soil moisture and clay content will increase treatment costs. The technology is not currently approved in On-

tario for the treatment of chlorinated organics, and cannot be used to treat contaminated soils containing hazardous levels of metals because of the possibility of volatilizing certain metals. A schematic of the low-temperature thermal desorption process is provided in Figure 6.

Solidification/Stabilization

Solidification/stabilization technologies are applied *ex situ* or *in situ*, and involve

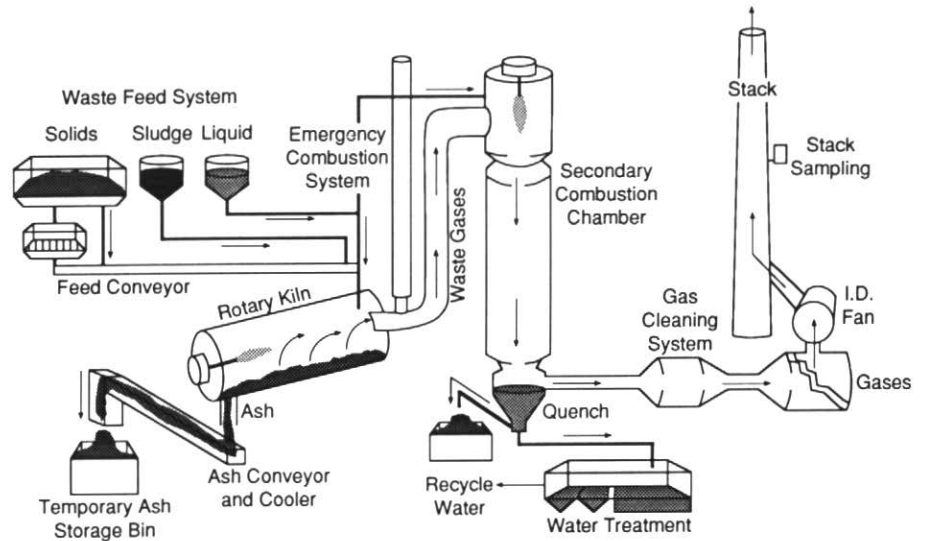

Figure 5 Typical rotary kiln incinerator.

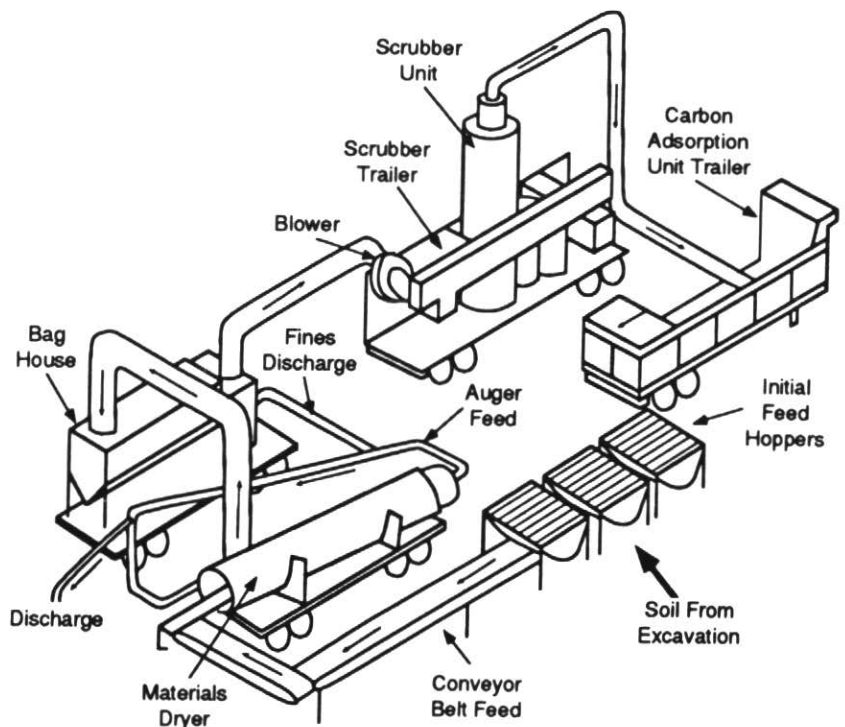

Figure 6 Low-temperature thermal desorption.

the addition and mixing of reagents to the contaminated soil. The reagents serve to bind the contaminants through adsorption processes and solidify the material to form a stable, solid mass which is mechanically competent, and resistant to the effects of freeze/thaw and weathering.

The low permeability of the processed material minimizes the release and distribution of contaminants into the environment by such processes as leaching, volatilization or wind. Portland cement, lime diatomaceous earth, and fly-ash are common reagents in the solidification/stabilization process.

Solidification/stabilization is suitable for treatment of heavy metals, but while some vendors claim effectiveness in treating organic wastes, there is very little evidence to support these claims. It is also not clear whether solidified/stabilized material will withstand tens and hundreds of years of weathering. The addition of reagents could increase the initial volume of material by 10-30%. Heat generated by the addition of reagents may result in significant emissions of volatile chemicals from the contaminated soil. In some jurisdictions, solidified materials must be landfilled, which adds to the treatment costs. High clay and organic content in contaminated materials will result in a structurally weaker solid mass.

Other forms of stabilization include asphalt batching and encapsulation. Asphalt batching incorporates contaminated material into asphalt materials for reuse in road surfacing materials. Contaminated materials used for this process are restricted by clay content and the amount of any fuel or solvent contamination, since these materials will lower the strength of the final asphalt

product. Encapsulation involves the mixing of plastic resins, which surround and encapsulate the contaminant, producing a solid material that has very low permeability.

Soil Washing

Soil washing is a well-developed *ex situ* technology for the treatment of contaminated soil. The process technology has a long history of use in Canada in the mining and metal processing industry, but has only recently been applied to large-scale clean-up of contaminated soils. Soil washing is a separation technology that is suitable for the treatment of inorganic and organic contaminants.

Contaminated soil is first pretreated by screening out large objects. The soil is then directed to a vessel containing water which agitates the soil, and through the process of attrition scrubbing, the mechanical shearing action of the soil particles against one another removes adsorbed contaminants. The soil is separated by density and size. The coarse particle fractions are cleaned quickly and can be returned to the site as clean fill. The finer-grained fractions may require additional treatment. Variations on this process include the use of high-pressure washing to remove adsorbed contaminants. This process works best on coarse-grained materials such as sands and gravels. With increasing clay content, the washing process becomes more complex, resulting in higher treatment costs. Chemical additives such as acids and surfactants can be added to facilitate the removal of specific contaminants. Chelating agents can be added to metal-contaminated soils to recover specific metals which can be sold for reuse.

Soil-washing facilities can be estab-

lished as fixed or mobile facilities. Treatment costs are competitive with alternative treatment for hazardous waste, but are likely too expensive at the present time for treatment of non-hazardous waste. The process separates the contaminants from the coarser fraction of soil. The final product includes a cleaned soil and a concentrated contaminant sludge which requires further treatment and/or disposal.

Hydraulic Fracturing

Fine-grained materials pose a problem for clean-up because their low permeability decreases advective transport and increases the time required to remove contaminants from the soil. Hydraulic fracturing is an *in situ* technology that has been used in the oil industry for secondary recovery of crude oil, and in the water well drilling industry to improve the yield of water wells. It is now being applied to contaminated soils to enhance permeability for the removal of volatiles by soil vapour extraction and to promote bioremediation. The mechanics of hydraulic fracturing in rock are well understood. Hydraulic fracturing in unconsolidated materials, for the purpose of enhancing permeability, is a more recent area of research.

As hydraulic pressure is applied, the generation of fractures occurs at a critical pressure. As hydraulic pressure increases, fractures are propagated and as propagation continues, there is a rapid decline in pressure as the fractures develop. The procedure is shown in Figure 7. The application of hydraulic-fracturing technology is described by U.S. EPA (1993b) for enhancing permeability of soil for the purpose of soil vapour extraction. The following results were observed: 1) fractured wells

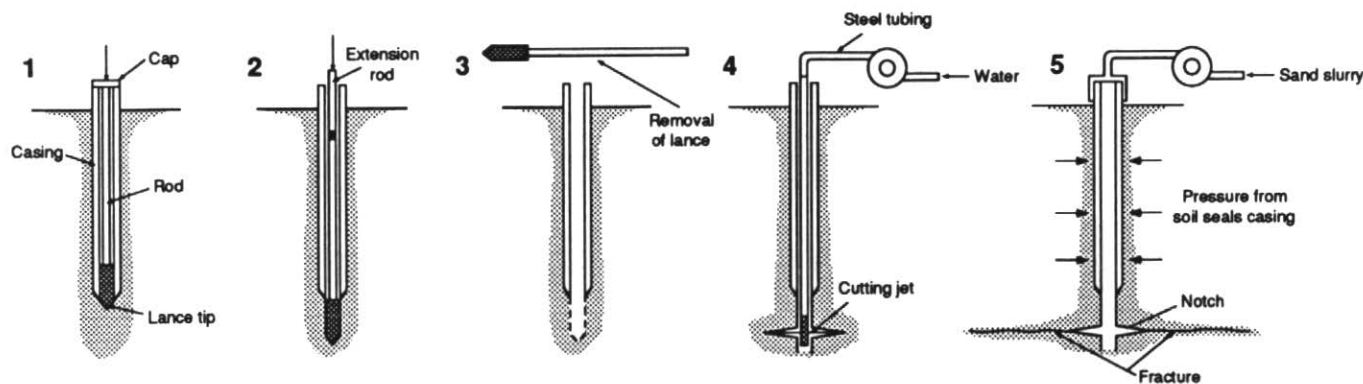

Figure 7 Method of hydraulic fracturing.

showed increases in vapour flow rates of fifteen times those of unfractured wells; 2) contaminant mass recovery rates were seven to fourteen times greater in fractured wells than non-fractured wells; and 3) the radius of fracture propagation was estimated to be 8 m.

Steam Injection

The injection of hot water and steam *in situ* has been used extensively in the oil industry as a technique for secondary oil recovery. The application of this technology to the treatment of sites contaminated with volatile and semi-volatile organic compounds is in the pilot scale and field scale stage of development. Steam is generated from an on-site steam boiler, and is injected into the zone of organic contamination by means of injection wells. A steam front advances through this zone, decreasing viscosities and interfacial tensions between the water and the organic compound and resulting in improved contaminant mobilization. Volatile components of organic contaminants are distilled from the zone of contamination and subsequently condensed into the steam front, producing a front of mobile organic liquids. Extraction wells are used to pump organic liquids and ground water to the surface for treatment and to recover steam and vapourized contaminants. Ground water is directed through an oil/water separator prior to treatment, and is discharged to a storm or sanitary sewer. The vapour phase contaminants can be treated using thermal or catalytic oxidation, or can be condensed for recycling or treatment.

A schematic of a steam-enhanced recovery system is provided in Figure 8. The technology has been demonstrated at sites contaminated with volatile fuels, chlorinated solvents, and semi-volatile fuels and oils (Hughes Environmental Systems Inc., 1992; Udel Technologies, Inc., 1992). The use of steam injection in the recovery of DNAPL compounds requires considerable care in design and operation to prevent uncontrolled mobilization of DNAPL.

Naturalization

Certain vegetation types have been found to be effective in enhancing the biodegradation of pesticides, chlorinated solvents, light-fraction aromatic and aliphatic petroleum hydrocarbons and polycyclic aromatic hydrocarbons

in their root zones, and the uptake of metal contaminants. The root zone, or rhizosphere, typically shows increased microbial activity of one or more orders of magnitude compared to soil outside of the root zone. The composition of microbial communities is dependent on several factors including root type, plant species, plant age, soil type, and the type of contaminant that is present in the soil. The vegetation itself influences conditions in the rhizosphere that are significant in promoting the development of biomass. These conditions include oxygen and carbon dioxide concentration, osmotic and redox potentials, moisture content, and pH.

Plant root systems provide the supporting structure on which microbial populations can develop. Plant species that develop fibrous root systems provide a larger surface area than tap root systems, and can support a larger microbial population. As well, root cells secrete nutrients that are necessary to maintain microbial respiration. Research into the assessment of specific plant species to degrade or uptake specific contaminants is ongoing.

The use of naturalization is a long-term strategy, and should only be considered in areas that do not require immediate remediation. Restricted access to areas undergoing remediation

by this method may be necessary. Long-term monitoring of soil, and possibly ground-water, quality would be necessary to determine whether naturalization processes are effective.

Excavation/Landfilling

Excavation and landfilling of soil is currently the most popular method of dealing with non-hazardous contaminated soil in Canada, given the relatively low cost for disposal. Very few treatment technologies are able to compete with the current low tipping fees at landfills. As the cost of disposal rises, alternative methods of treatment become economically viable. In some jurisdictions in the United States, soils containing certain levels of hazardous materials can no longer be landfilled, and require alternative methods of disposal. This has favoured the development of alternative technologies.

Disposal of contaminated soil at a landfill is perceived by some to be a band-aid solution, since the environmental issues associated with contaminated soils are not resolved, but moved from one jurisdiction to another. As well, in some jurisdictions, owners of contaminated soil who dispose of their soil at landfills may be subject to future liability, should there be any pollution claims against the landfill as a result of

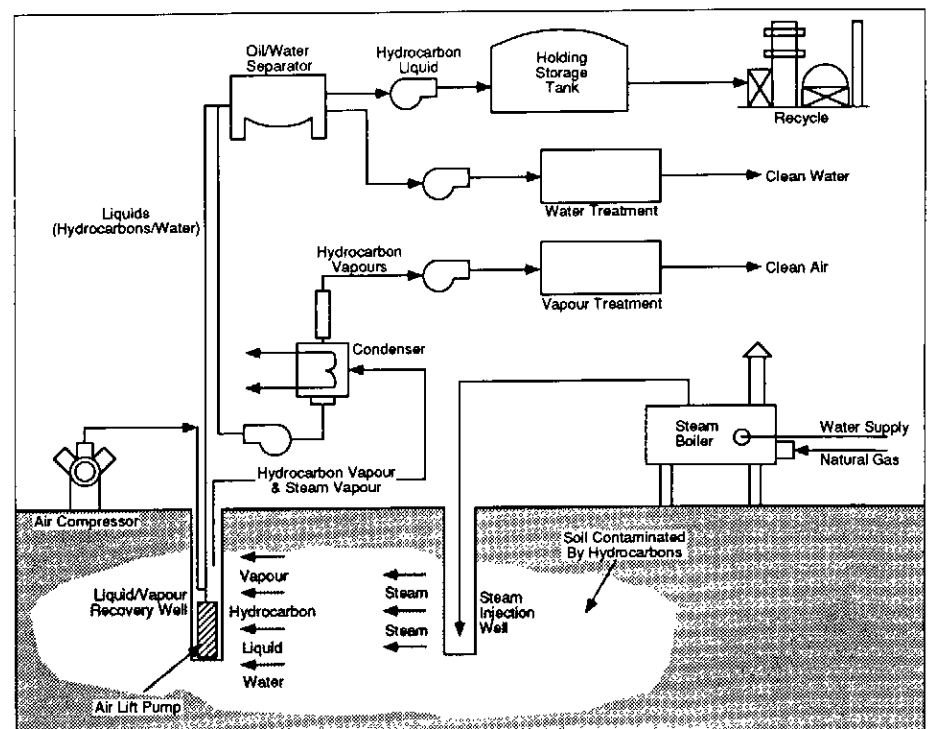

Figure 8 Steam-enhanced recovery process.

contamination of water supplies from landfill leachate.

Soil Vapour Extraction

Soil vapour extraction is an *in situ* technique that is used to remove volatile contaminants from the unsaturated zone. It is commonly used to remediate gasoline spills and is useful for remediation around structures where excavation could result in damage to the structure. A typical soil vacuum extraction system includes an array of wells installed in the areas of contamination in the unsaturated zone. The wells are connected to headers, which are attached to a knockout drum and vacuum pump. When a vacuum is applied to the wells, the lower pressure at the well screen causes air flow to occur in the soil from areas of higher pressure (atmospheric) located away from the wells. The air stream that is extracted at the well includes volatile contaminants and soil moisture. A knockout drum is attached in front of the vacuum pump to remove moisture from the airstream.

Soil vapour extraction is a separation technology. The separated contaminants in the airstream require further treatment to prevent release of contaminants to the atmosphere. The most common treatment methods include ac-

tivated carbon, thermal and catalytic oxidation, and biofilters. The use of activated carbon would require further processing or treatment when the carbon becomes saturated with the contaminant. Further treatment could involve landfill disposal or regeneration of the carbon.

Soil vapour extraction is most effective with volatile contaminants which have vapour pressures of greater than 0.5mm Hg and dimensionless Henry's Law constants of greater than 0.01 (United States Environmental Protection Agency, 1991), as shown on the nomograph in Figure 9. Finer-grained soils such as silts and clay silts would require permeability enhancement using methods such as hydraulic fracturing described above.

Depending on the depth of contamination, air flow can be controlled by sealing the surface to prevent the short-circuiting of air flow. If the vacuum extraction wells are located near the water table, the lower pressure in the wells may cause the water table to upwell in the vicinity of the wells, reducing the efficiency of the process. In such cases, dewatering and possibly ground-water treatment may need to be considered.

Prior to full-scale clean-up, a pilot air extraction test should be conducted to provide site-specific design parameters

including radius of influence of extraction wells, contaminant concentration in air, vacuum pressures and changes in water level. This data will be used to design the full-scale system for such design parameters as number and location of extraction wells, vacuum pump size, estimated mass removal rate, length of time of treatment. A schematic for soil vapour extraction is provided in Figure 10.

Solvent Extraction

Solvent extraction is an *ex situ* chemical separation technology that uses solvents to solubilize contaminants and remove them from the soil matrix. The process is similar to soil washing (see above). Soil is screened for size and conveyed to a reaction vessel where the solvent is added. The waste stream from this process includes a cleaned soil stream and a mixed stream containing the solvent, contaminant and fines. Further separation of the mixed stream is conducted to redirect the fines back into the system for further treatment if necessary, separate the solvent for reuse, and collect the contaminant for disposal or resale. Solvent extraction technologies can be complex systems because they involve two different processes: the separation of the contami-

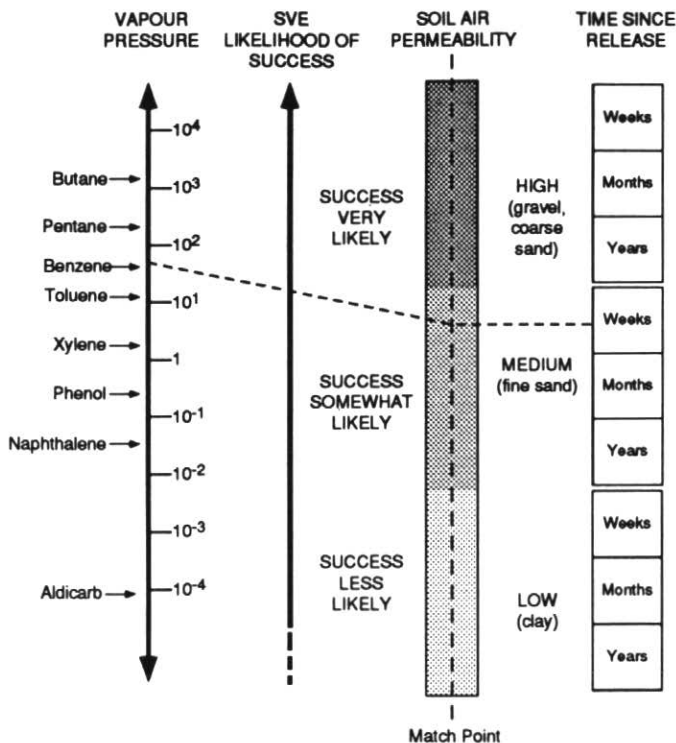

Figure 9 SVE (soil vapour extraction) applicability (see Fig. 10).

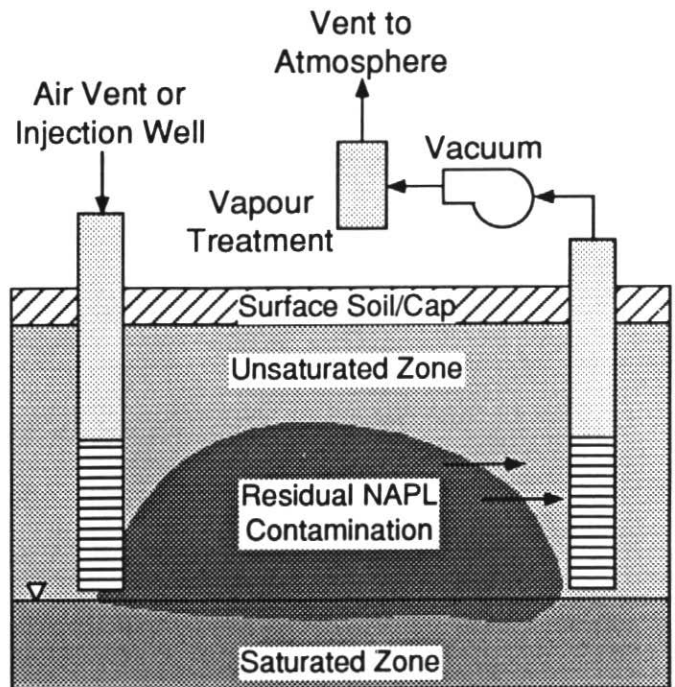

Figure 10 Soil vapour extraction.

nant from the soil matrix and the separation of the contaminant from the solvents. As well, treatment of any process water may be required to meet discharge criteria.

Thermal Reduction

Thermal reduction is a process that uses a high-temperature, highly reducing hydrogen environment to destroy chlorinated organic compounds including PCBs, chlorinated solvents, and dioxins and furans. The process is not considered to be an incineration process because oxygen is not involved in the reaction.

The main component of the process is the reactor module. The waste soil is preheated and injected into the reactor in the presence of hydrogen. The mixture is heated to 850°C as it falls through the reactor. Particulates up to 5 mm in diameter that are not entrained in the gas mixture, impact the walls of the reactor and volatilize organic matter adsorbed onto the particulate. The particulate falls through the reactor into a quench tank and is removed (United States Environmental Protection Agency, 1994b).

PCBs are destroyed in the process by the following reactions:

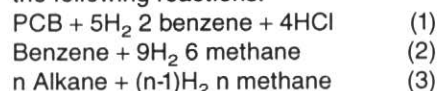

The process has undergone a number of field demonstrations and is commercially available. The system is mobile and can be transported to the site on two tractor trailers. Following the reaction, gases are cooled with scrubber water which removes hydrogen chloride. The process produces a sludge and decant water waste streams. The final gas stream consists of hydrogen, methane and ethylene, most of which is recirculated back into the reactor or is used to preheat the incoming waste stream.

Reduction-Oxidation Reactions

Reduction-oxidation reaction technology is a chemical method that destroys organic contaminants through the addition of reagents that break down the chemical structure of the contaminant. Reduction reaction technology is used in the destruction of chlorinated compounds such as PCBs. An example of a reduction reaction is where an alkali metal reacts with glycol to produce an alkoxide. The alkoxide substitutes for

chlorine on the chlorinated compound to form an ether and an alkali metal salt. The process involves the pre-screening of contaminated soil for size. The reagents are pre-mixed and added to the soil in a closed reaction vessel to form a slurry. The slurry is heated for some period of time, depending on the nature of the contaminant and matrix. Following the reaction, unreacted reagent is removed. The cleaned soil is washed with water. Volatile emissions and wash water are treated prior to disposal. This process has been demonstrated at field scale at several PCB contaminated sites in the United States (United States Environmental Protection Agency, 1989).

Bioremediation

Bioremediation is a destructive technology that has had widespread application in the clean-up of soil and ground water contaminated with light hydrocarbons such as fuels and light oils. Research and field studies are being conducted to determine its application to the treatment of more recalcitrant organic compounds such as PAHs, and chlorinated aliphatic and chlorinated aromatic compounds.

Bioremediation is a process that can occur over a wide range of chemical conditions in the presence of free oxygen (aerobic conditions) or without free oxygen (anaerobic conditions). Biodegrading microbes include bacteria and fungi which are naturally occurring in soil. Bioremediation technology involves the stimulation of growth of indigenous microbes to break down contaminants into less harmful transformation

products and, ultimately, to carbon dioxide. Some vendors add proprietary genetically engineered microbes to stimulate biodegradation, but it is believed that these are generally short-lived, and the advantage of their addition is a matter of debate. The requirements for successful *in situ* bioremediation include 1) appropriate microbial conditions, and 2) appropriate hydraulic conditions. Growth of the microbial biomass requires a source of carbon (the contaminant), an electron acceptor (*e.g.*, oxygen, nitrate, sulphate, carbon dioxide), nutrients (phosphorus and nitrogen) and subsurface conditions friendly to the microbes (*e.g.*, temperature and pH).

Bioremediation is a destructive method that is suitable for clean-up of organic compounds, particularly the light- to mid-range fraction of petroleum hydrocarbons and the lighter fraction PAHs (François and Molyneux, *in press*). Several methods have been developed using bioremediation technology either *in situ* or *ex situ* and include bioventing and various types of bioreactors.

Bioventing is an *in situ*, aerobic bioremediation method that involves the movement of air through the subsurface, directly by means of blowers or indirectly by means of vacuum pumps. The circulation of air containing oxygen facilitates *in situ* bioremediation, and would be suitable for those areas containing petroleum hydrocarbons in the soil zone above the water table. A schematic showing bioventing with nutrient and moisture addition is provided in Figure 11.

Slurry bioreactors are an *ex situ* bioremediation technology that requires

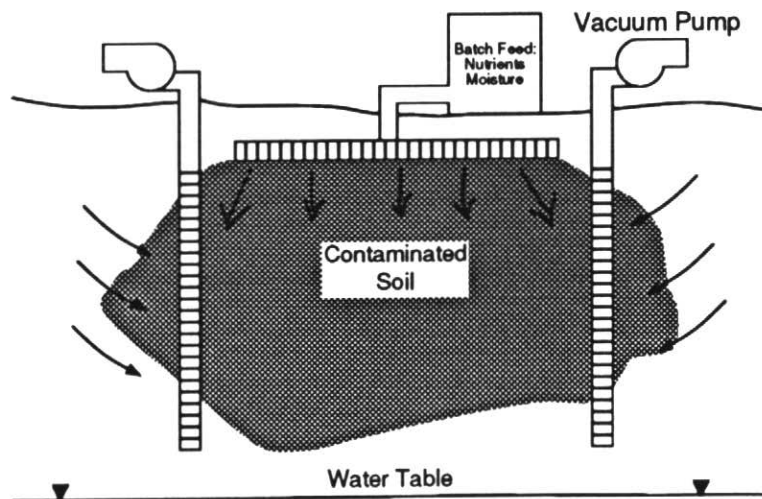

Figure 11 Bioventing (after National Research Council, 1994).

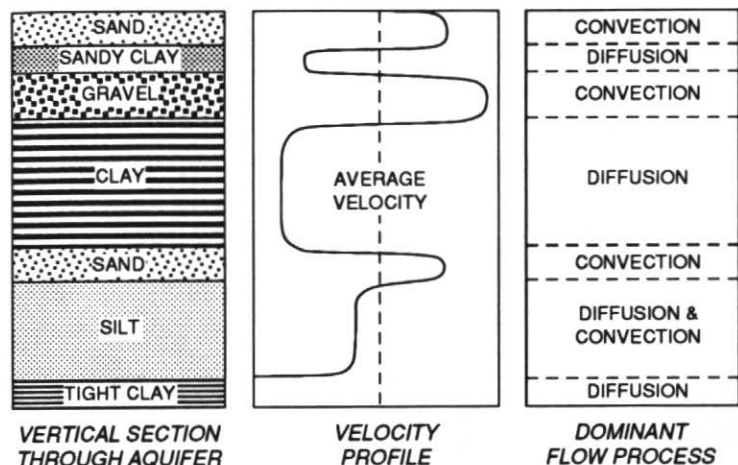

Figure 12 Influence of geological stratification on ground-water flow.

excavation of contaminated soil and transfer into a reactor vessel. The vessel could include some form of enclosed tank or an open lagoon. Contaminated soil is added to water to form a slurry that is 10-20 weight percent of solids to maintain particle suspension (Brox and Hanify, 1989). Nutrients and electron acceptors can be added in appropriate concentrations to match contaminant concentrations in the slurry and optimize biodegradation. While slurry bioreactors are restricted by the size of the vessel as to the volume of material that can be treated, residence time can be considerably shorter than other types of reactors because of the ability to control conditions that increase rates of biodegradation.

Prepared-bed reactors are an *ex situ* bioremediation method that involves piling contaminated soil into prepared reactor beds (also termed engineered bioremediation cells, see Hubley, *et al.*, in press for a case example). They operate at a slower rate than slurry bioreactors, but are capable of treating larger volumes of soil. Space requirements for prepared-bed reactors are greater than for slurry bioreactors. *In situ* bed reactors involve *in situ* deep tilling of soil, with the addition of organic soil amendments which facilitate the bioremediation of the heavier and more recalcitrant petroleum hydrocarbons and PAHs.

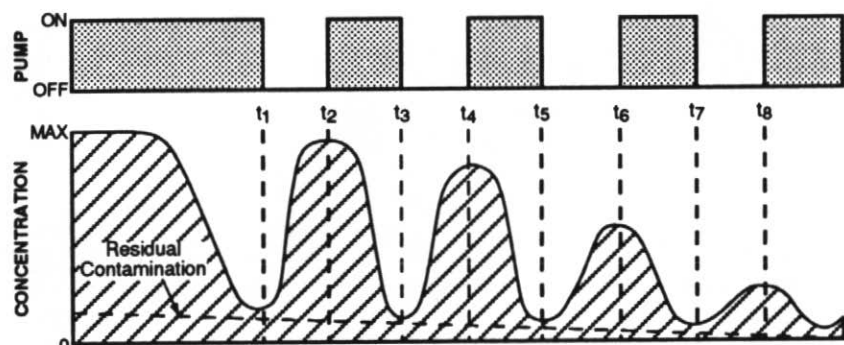

Figure 13 Variation in contaminant concentration with pulsed pumping (after Mercer *et al.*, 1990).

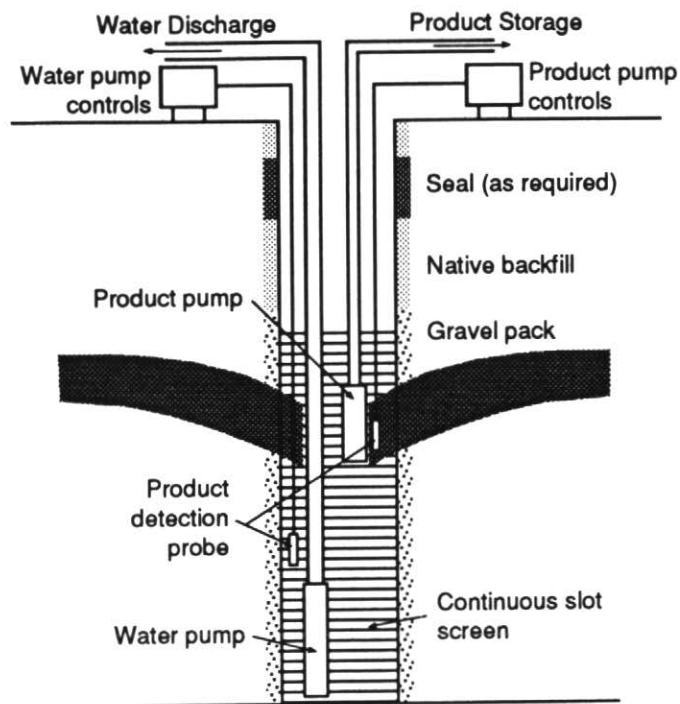

Figure 14 Recovery of free product using two-pump system (after Domenico and Schwartz, 1990). See also Chapter 7.

Electrokinetics

Electrokinetics involves the application of a low-voltage direct current across a saturated soil mass, which results in the transport of ionic species toward the current electrodes (Acar and Alshawabkeh, 1993). Electrokinetics is a separation technology that is suitable for the treatment of metal contaminants in soil that occur below the water table. Metal ions migrate toward the cathode, where fluids containing the metal contaminants are removed from the subsurface by pumping, and the fluid is treated on surface for metal recovery using standard treatment methods. Application of electrokinetics to soil and ground-water clean-up is still at the field or pilot scale stage in North America. It has been used in site clean-up in the Netherlands since 1987 (Lageman, 1993).

Ground-water Remediation Technologies

In the United States, more than three-quarters of the Superfund sites use

pump-and-treat systems to remediate contaminated ground water. Pump-and-treat involves the pumping of contaminated ground water to the surface through a series of extraction wells where it is treated and discharged.

Early on in the application of pump-and-treat, it was thought that by pumping a volume of water equal to the pore space of the aquifer, a significant volume of contaminant would be removed. Due to heterogeneities within a stratigraphic sequence, contaminant migration may be dominated by convection in permeable zones or by diffusion in low-permeable materials as illustrated in Figure 12. Depending on site conditions and the age of the contamination, pump-and-treat type treatment is often characterized by decreasing concentrations of contaminants with pumping time. The contaminants may reach a level that is below ground-water clean-up guidelines, at which time the pumps are shut off. After some period of no pumping, the contaminant concentration starts to increase. This observed increase in concentration with time is attributed to contaminant desorption and diffusion from fine-grained materials adjacent to or within the aquifer. The pump-and-treat process must then be started again, until such time as the contaminant reduces to a level that is below ground-water clean-up guidelines. This cycle of pulsed pumping is illustrated in Figure 13.

Experience in the United States has shown that pump-and-treat is severely limited in its ability to restore contaminated aquifers, because contaminants remain within the soil matrix (see Feenstra, in press for discussion).

Hydraulic Fracturing

Hydraulic fracturing (see above) can be applied to the saturated zone to improve hydraulic conductivity and improve the efficacy of pumping for pump-and-treat and *in situ* methods of ground-water treatment.

Free-Product Recovery

Petroleum hydrocarbon fuels such as gasoline and diesel fuel (LNAPLs, Fig. 1) are common contaminants in soil and ground water. Recovery can be completed using pumps or interceptor trenches. Figure 14 depicts a recovery well. A water pump located near the bottom of the well is used to lower the water level in the well and create a cone

of depression around the well. This cone of depression induces free product to flow into the void space previously occupied by the water, and allows a greater thickness of product to accumulate. A separate product pump is used to pump product from the well to the surface, where it is stored for disposal or re-refining.

Alternative methods of product recovery, which may be suitable for shallow ground-water conditions, involve the use of interceptor trenches which are dug below the water table. Product flows into the trench under natural hydraulic up-gradients, and is removed by a floating skimmer. The down-gradient side of the trench is covered with an impermeable barrier, such as plastic film, to contain the product in the trench until it can be pumped out. A schematic of an interceptor trench system is shown in Figure 15. François and Molyneux, in press provide case examples of the use of recovery wells and interceptor trenches to remove petroleum products from the shallow subsurface.

Pump-and-Treat

The following five common treatment technologies are reviewed: granular activated carbon, air stripping, filtration processes, advanced oxidation, and bioreactors.

Granular activated carbon. Granular activated carbon (GAC) has been used to remove organic contaminants from drinking water since the 1940s when its use in treating municipal water supplies became widespread. GAC is manufactured from a variety of source materials which include coal, wood, peat and coconut shell. The source material is first crushed to a powdered

form, then roasted to produce charcoal. The charcoal is then activated by roasting again in a low-oxygen environment, in the presence of steam, which creates numerous pits and grooves in the charcoal particles. This action significantly increases the surface area of the particles (Lehr, 1991). GAC works by adsorbing organic contaminants onto its surface, where the forces of attraction between the carbon surface and the organic contaminant are greater than the forces that keep the organic contaminant in solution. Organic compounds that readily adsorb onto GAC are those with a relatively low water solubility and a large molecular weight.

Physical properties of GAC that are used to determine its effectiveness for treatment include surface area, density, mesh size, abrasion resistance, and ash content (Delthorn and Mazzoni, 1986). The larger the surface area of the GAC, the more efficient the removal process will be, provided that the pore size in the GAC is suitable for the size of the contaminant molecule. Mesh size describes the size of individual GAC particles. A smaller mesh results in a larger pressure drop across the carbon bed, resulting in longer retention time within the bed and greater adsorption of the contaminant. Abrasion resistance reflects the ability of the carbon to resist breakage during handling, and is an important consideration where back-washing of the carbon bed is required. Ash content reflects the purity of the carbon. Impurities in the carbon may be released during back-washing and may affect water quality.

In addition to the treatment of liquid phase contaminants in ground water, GAC can be used for the treatment of gas phase contaminants which would

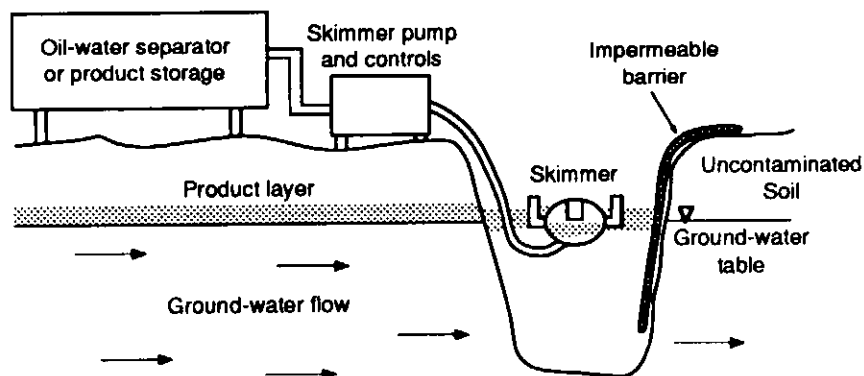

Figure 15 Recovery of free product using an interceptor trench (after Domenico and Schwartz, 1990).

be generated during air stripping or soil vapour extraction. GAC can be purchased in bulk or in pre-packaged systems ranging in size from 45-gallon drums to large trailers. Once all the adsorption sites on the carbon are full, the carbon has no further capacity to adsorb the contaminant, and breakthrough of the contaminant can occur. Therefore, it is common practice to establish GAC treatment in series, so that contaminant breakthrough can be contained. Monitoring of the influent and effluent stream is a key component of GAC treatment.

Air stripping. Air stripping is a well-developed technology for the separation and removal of volatile organic compounds from contaminated ground water. The ability of air strippers to remove contaminants from ground water is a function of the contaminant's ability to partition from water into air. This partitioning can be quantified by the Henry's Law constant for the contaminant, which is derived from the ratio of the contaminant's vapour pressure to its solubility in water (François and Molyneux, in press). Contaminants with a low solubility in water and a high vapour pressure have large constants and will tend to partition readily from water to air. These contaminants are good candidates for air stripping.

Contaminants with Henry's Law constants of greater than about $5 \times 10^{-3} \text{ atm m}^3 \cdot \text{mol}^{-1}$ can be considered as strippable. This would include common contaminants such as tetrachloroethene (perchloroethylene), trichloroethene, benzene, xylene and toluene. Air-stripping systems can consist of packed towers, diffusers, trays or spray sys-

tems. Each is designed to increase the contact time between the influent contaminated ground-water stream and a counter-current flow of air which removes the contaminant from the water. The stripping process generates a contaminated air stream which requires further treatment, which commonly includes granular activated carbon, oxidation processes, or bioremediation.

Filtration processes. Filtration involves physical/chemical processes that remove or separate the contaminant from the liquid, leaving a contaminant concentrate that requires further treatment or disposal. Filter membranes can include manufactured membranes such as cellulose acetate or silicone rubber, or formed-in-place membranes consisting of layers of inorganic and polymeric coatings on rigid, porous plates or tubes. Filtration technologies are described in U.S. EPA (1992a, b, 1993c, d). Filter membranes and formed-in-place membranes are porous materials that allow ions and compounds less than a critical size to pass through, while retaining larger sized species or compounds. Filters can be used to treat ground-water waste streams containing heavy metals, as well as organic compounds ranging from large molecular-weight organics such as polyaromatic hydrocarbons to lower molecular-weight organics such as toluene and trichloroethylene.

Dissolved metals require pre-treatment prior to filtration in order to increase the diameter of the contaminant and prevent it from passing through the membrane. Pre-treatment includes the addition of reagents to form larger metal precipitates or metal polymer com-

plexes which can then be effectively filtered.

A filter operating in cross-flow mode, as shown in Figure 16, involves a series of hollow tubes through which the contaminated ground water is pumped. The filter selectively prevents the contaminant from passing through the filter, while allowing the permeate to flow through the sides of an inner tube into an outer tube. The permeate is collected and further treated as necessary prior to discharge. The contaminant is concentrated in the inner tube and collected for recycling or disposal.

Filtration technology at bench and pilot scale indicated greater than 95% removal rates for mercury, cadmium and lead (United States Environmental Protection Agency, 1992a). Treatment of metals may require pre-treatment to remove elevated levels of iron, sulphate and calcium in the feed. Removal efficiencies of 95 to 99% were reported for toluene, trichloroethylene and PAHs (United States Environmental Protection Agency, 1992b; 1993d).

Advanced oxidation. Advanced oxidation processes using photo-oxidation are used in the treatment of organic compounds and offer advantages over filtration and other separation technologies because photo-oxidation results in the destruction of the contaminant. Advanced oxidation involves the formation of a hydroxyl radical (OH^\cdot), a powerful oxidizing agent that reacts extremely rapidly with almost all organic compounds, at rates which are typically one million to one billion times faster than reactions with molecular ozone alone.

The hydroxyl radical can be generated from the reaction between ozone or hydrogen peroxide and ultraviolet light (United States Environmental Protection Agency, 1993e; 1993f), cavitation (United States Environmental Protection Agency, 1993g), or electron beam (United States Environmental Protection Agency, 1992c; 1993h, 1993i). Once generated, the hydroxyl radical reacts rapidly to oxidize organic compounds in solution to carbon dioxide and water. Where chlorinated organic compounds are involved, chloride is also produced. In addition to oxidation of organic compounds by the hydroxyl radical, organic compounds also undergo photochemical destruction. The ultra violet source produces

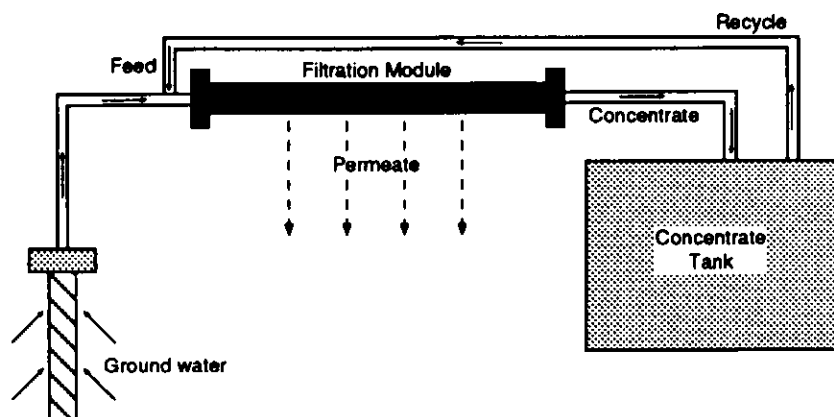

Figure 16 Schematic diagram of filtration process (after United States Environmental Protection Agency, 1992c).

light at a wavelength of less than 300 nanometres (nm). Many of the problematic organic contaminants, such as the chlorinated solvents and many of the intermediate species generated during the photochemical/oxidation reactions, react strongly to light with wavelengths at or below the range of 250-300 nm (United States Environmental Protection Agency, 1993f).

Advanced oxidation using photo oxidation is suitable for the treatment of most organic contaminants including petroleum hydrocarbons, PAHs, chlorinated solvents, pesticides, PCBs and chlorinated phenolics. Commercial skid-mounted reactors are custom built to the nature of the contaminant and the contaminant through-put. The reactor consists of one or more vertical cylinders equipped with a UV lamp and a quartz sleeve. The influent-contaminated ground water is pumped through a line where hydrogen peroxide or ozone oxidants are added and mixed prior to entering the reactor. The ground water is treated in the reactor, and the effluent is sampled to ensure compliance with discharge criteria. A schematic showing an advanced oxidation reactor is provided in Figure 17.

Bioreactors. Bioremediation has

previously been discussed with respect to the clean-up of contaminated soil, and is discussed later with respect to *in situ* methods of ground-water treatment. Bioreactors used to treat ground water (*ex situ*) that has been pumped from a contaminated area utilize a reaction vessel to optimize biodegradation of the contaminant inside the vessel. Design criteria for bioreactors include the type and concentration of contaminant, ground-water flow rate, clean-up criteria for contaminated ground water, and additional constituents in the ground water such as heavy metals that may inhibit microbial activity.

Chemical Flushing

Flushing of chemicals through the contaminated porous medium to enhance the solubility of contaminants has been applied at sites contaminated with NAPLs, as well as metals. The use of surfactants to mobilize petroleum hydrocarbons has been used in the petroleum industry to enhance oil recovery. The purpose of the surfactant is to 1) increase the solubilization of the contaminant, 2) increase desorption of the contaminant from the aquifer matrix, and 3) lower the interfacial tension of the contaminant with water. The surfactant is added to water in concentrations

typically ranging from 0.5% to 5% by weight of the solution. In water, the surfactant forms colloidal clusters of molecules, called micelles, which consist of a hydrophilic sheath surrounding a hydrophobic core. At the interface between the NAPL and water, the micelles become re-oriented, so that the hydrophobic group is in contact with the NAPL while the hydrophilic group remains in contact with the water. The non-polar hydrophobic group allows non-polar NAPLs to solubilize into the interior of the micelle. The process is illustrated in Figure 18.

The formation of micelles leads to lowering of the interfacial tension (IFT) between the NAPL and water, thereby reducing the capillary forces on the NAPL and increasing the mobility of NAPL. While the lowering of IFT is an important property of the surfactant, maximum reduction in IFT may not be desirable because of the possibility of the uncontrolled remobilization of the NAPLs, particularly those that have a higher density than water (DNAPLs). Surfactants can be selected that provide significant reduction in IFT without causing vertical migration.

Experiments on the biodegradability of surfactants have shown that surfactants can be selected to biodegrade

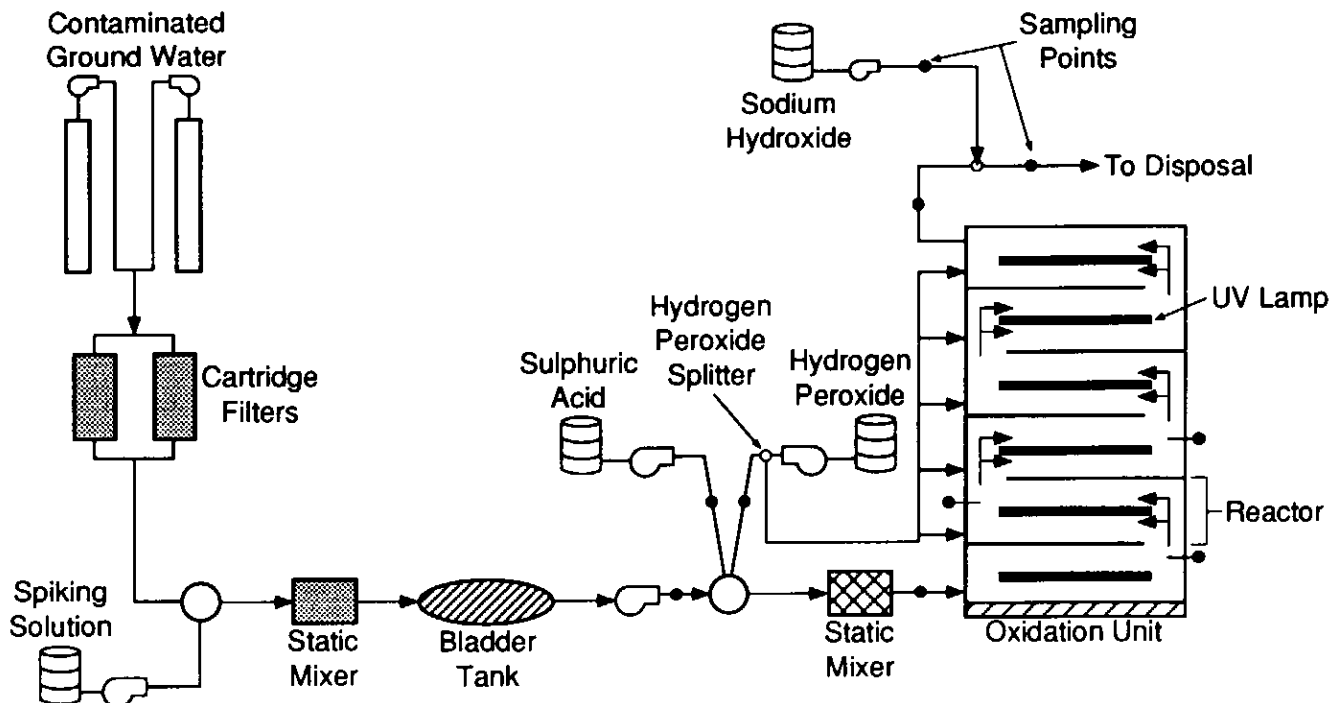

Figure 17 Schematic of photo oxidation treatment system (after United States Environmental Protection Agency 1993e).

under aerobic and anaerobic conditions. As well, there is evidence that surfactants can co-metabolize recalcitrant chlorinated organic compounds by acting as primary substrates for microbial activity (Jackson *et al.*, 1992).

Field tests using surfactants on a controlled spill of perchloroethylene (PCE) indicated that, while pump-and-treat without surfactants showed virtually no effect on PCE removal, the addition of surfactants to enhance pump-and-treat resulted in the removal of free-phase PCE from the field study without any apparent vertical remobilization of the PCE (Jackson *et al.*, 1992). Figure 19 shows the decrease in PCE concentrations *versus* extracted pore volumes.

The lowering of the interfacial tension decreases the capillary pressure of contaminant within the aquifer matrix and

increases contaminant mobility. The increase in mobilization, solubilization and desorption results in an increase in the concentration of the contaminant in the ground water of up to several orders of magnitude, thereby significantly reducing the pumping time required to flush the contaminants from the aquifer.

Bioremediation

Ex situ bioremediation of pumped ground water has been discussed previously. *In situ* bioremediation, as with any other *in situ* process, requires careful characterization of the physical and chemical characteristics of the site and an understanding of the system hydraulics. As well, laboratory bench scale testing of the site microbiology should be undertaken to identify specific degrading microbes and conditions that

would optimize contaminant degradation. Following bench scale testing, the system should be assessed to determine whether conditions for optimum contaminant degradation can be developed at the site.

The design of an aerobic system to treat a contaminated ground-water plume involves extraction wells at the toe of the plume, a nutrient and oxygen supply at surface, and infiltration wells within the zone of contamination up-gradient from the extraction wells. Pumped water containing organic contaminants removed from ahead of the treatment front are treated prior to re-injection. A schematic showing an *in situ* bioremediation system is provided in Figure 20.

The electron acceptor under aerobic conditions is free oxygen (O₂), which can be delivered to the system by *in situ* air sparging (see following discussion), circulation of oxygenated water and the addition of hydrogen peroxide. Air sparging can raise dissolved oxygen concentrations to 8-12 mg·L⁻¹. The addition of hydrogen peroxide can raise dissolved oxygen concentrations to 40 mg·L⁻¹, but is subject to instability which can reduce its effectiveness. Under anaerobic conditions, electron acceptors can include nitrate, sulphate and carbon dioxide. Geological conditions (e.g., permeability, heterogeneities) and electron acceptors are often the limiting factors to successful *in situ* bioremediation of ground water.

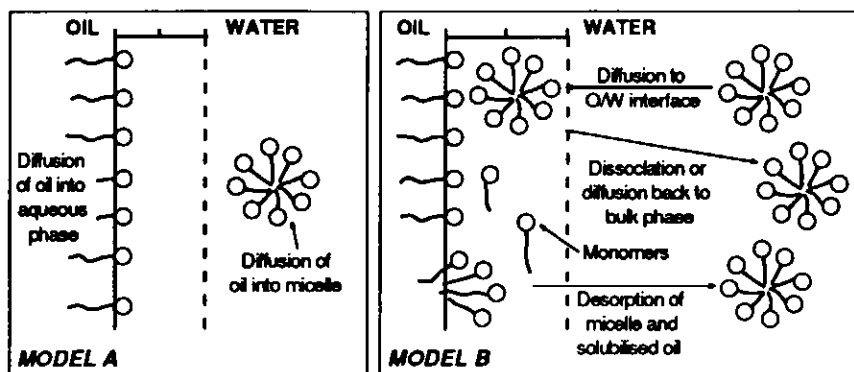

Figure 18 Solubilization of oil by surfactant micelles (after Jackson *et al.*, 1992).

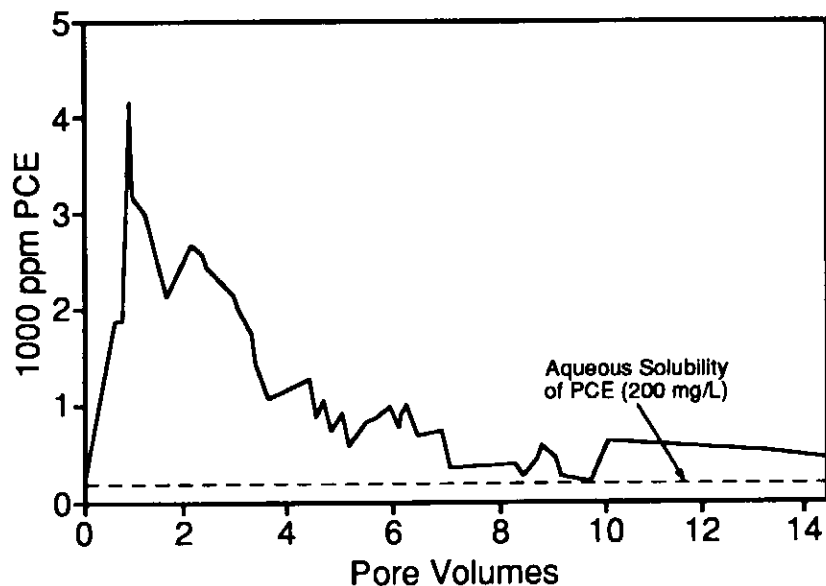

Figure 19 Effluent concentration of PCE (from Jackson *et al.*, 1992).

Air Sparging

Air sparging is used to treat dissolved and residual volatile organic compounds below the water table. The technology can effectively treat light petroleum hydrocarbon contaminants by volatilization and bioremediation (Marley and Droste, 1995).

Air sparging involves forcing air below the water table, through the zone of contamination, using a surface-mounted blower and an array of vertically or horizontally emplaced sparge points (Fig. 21). Vertically emplaced sparge points are typically constructed of materials similar to conventional ground-water monitor wells. They are completed in the saturated zone to a depth below the zone of contamination.

Sparge wells are connected to a header leading to a blower which is used to force air through screened portions of the sparge points. Air bubbles are forced into the formation and rise

upward to the zone of contamination. Air bubbles strip VOCs that are residually saturated in the aquifer and dissolved in ground water. Contaminants that are amenable to stripping include components of gasoline and chlorinated solvents.

The rising air/contaminant vapour stream results in increasing concentrations of VOCs in the unsaturated zone above the water table. In order to prevent uncontrolled migration of the contaminant in the unsaturated zone and uncontrolled emissions to the atmosphere, air sparging should be coupled with a soil vapour extraction system. Soil vapour extraction involves the installation of arrays of vertical or horizontal extraction wells in the unsaturated zone which are attached to a vacuum pump. Air containing VOCs is pumped from the unsaturated zone through a knockout pot to remove moisture, and directed to a treatment system to remove VOCs, using one of several technologies including activated carbon, catalytic oxidation or biofilters prior to discharge to the atmosphere. In addition to the *in situ* stripping of volatiles from below the water table, air sparging can also enhance *in situ* bioremediation of VOCs that are conducive to aerobic biodegradation (Fig. 22). A schematic showing the use of horizontal wells is shown in Figure 23.

The impact of air sparging on the concentration of VOCs recovered during soil vapour extraction is provided in Figure 24. The figure shows that when the air-sparging system is turned on, there is an immediate increase in the concentration of VOCs in soil gas.

Reactive Walls

Reactive walls are an *in situ* technology in which a permeable wall containing a suitable reactive material is placed down-gradient from a plume of contaminated ground water. As the ground water flows through the wall under natural gradients, the specific contaminant in the ground water reacts either directly or indirectly with the reactive material in the wall. A reactive wall is shown schematically in Figure 25. This technology can also be applied above ground where *in situ* applications are not feasible. In above-ground applications, the reactive material is held within a container and contaminated ground water is pumped through the reactive material.

Research at the University of Waterloo identified abiotic reductive dehalogenation reactions involving elemental iron as an electron source to

degrade halogenated methane, ethanes and ethenes to non-toxic reduced species (O'Hannesin and Gillham, 1992). A laboratory study showed sig-

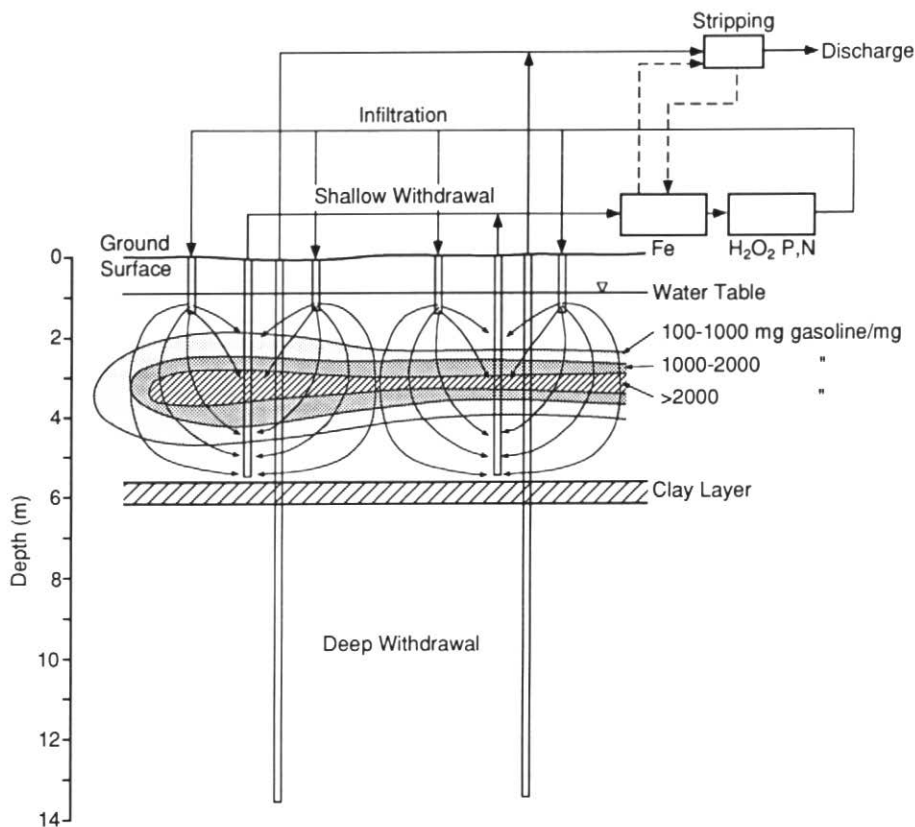

Figure 20 *In situ* bioremediation treatment system (after Stapps, 1990). Ex situ techniques requiring excavation of contaminated soil are discussed in Chapter 36.

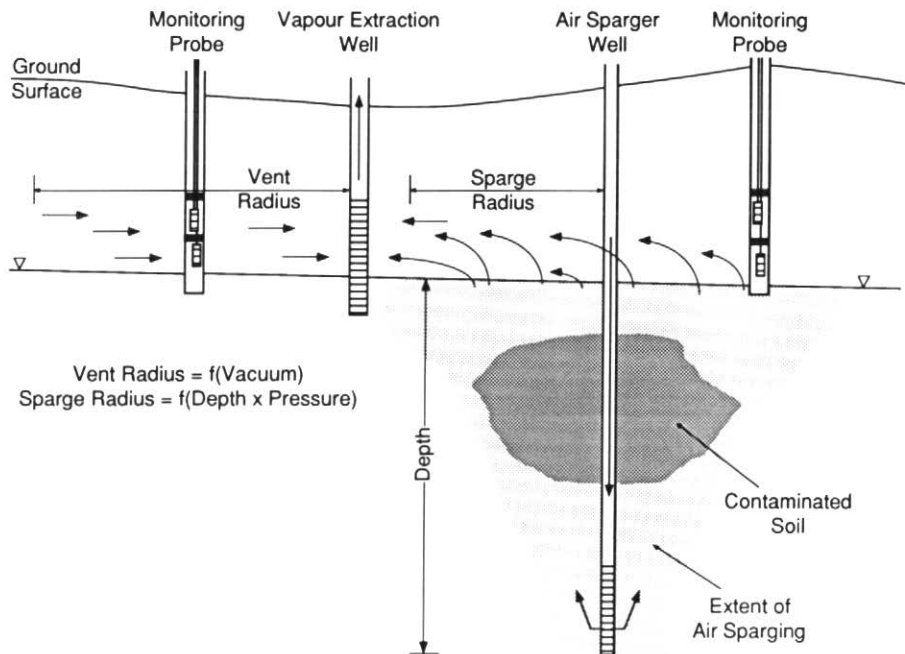

Figure 21 Typical air-sparging system.

nificant degradation of TCE after 50 hours contact time with a reactive metal as shown in Figure 26.

Greater control of system hydrodynamics and plume control can be obtained through the use of funnel-and-gate technology, where impermeable walls are used to funnel contaminated ground water through permeable gates in the wall that contain reactive material. A funnel-and-gate configuration is illustrated in Figure 27. Recent research in reactive wall technology involves the use of a proprietary mixture containing magnesium oxides that slowly releases oxygen when contacted with water. This process has potential application to enhance *in situ* aerobic bioremediation of petroleum hydrocarbons such as gasoline (Thomas and Mackay, 1994).

Constructed Wetlands

These are passive treatment systems that mimic natural conditions and have been applied to the treatment of acid mine drainage problems, municipal wastes and urban storm runoff. A more detailed review is provided in Be-rezowsky, in press.

Isolation

Isolation is a method of managing contaminated soil and/or ground water at a site by containing the contamination within physical barriers. Physical barriers could include low-permeability caps and walls.

The use of capping material over con-

taminated areas reduces the exposure of human and environmental receptors to the contaminant, and/or reduces the infiltration of precipitation through the contaminated zone. The reduction in infiltration can result in lower contaminant loadings from the unsaturated zone to ground water. Capping materials can include natural materials such as clay, or paving materials such as asphalt or concrete. Redevelopment of such sites can incorporate design and landscape features such as parking lots, roadways, structural envelopes,

berms or raised gardens over contaminated areas.

Where contaminant migration off-site must be controlled, low-permeability barrier walls constructed of grouted materials, clay, plastic membranes, or sheet piling can be installed. Barrier walls extend below the zone of contamination, and are tied into a low-permeability zone to facilitate hydraulic containment. Hydraulic containment can be further enhanced by maintaining inward hydraulic gradients into the contained area through ground-water pum-

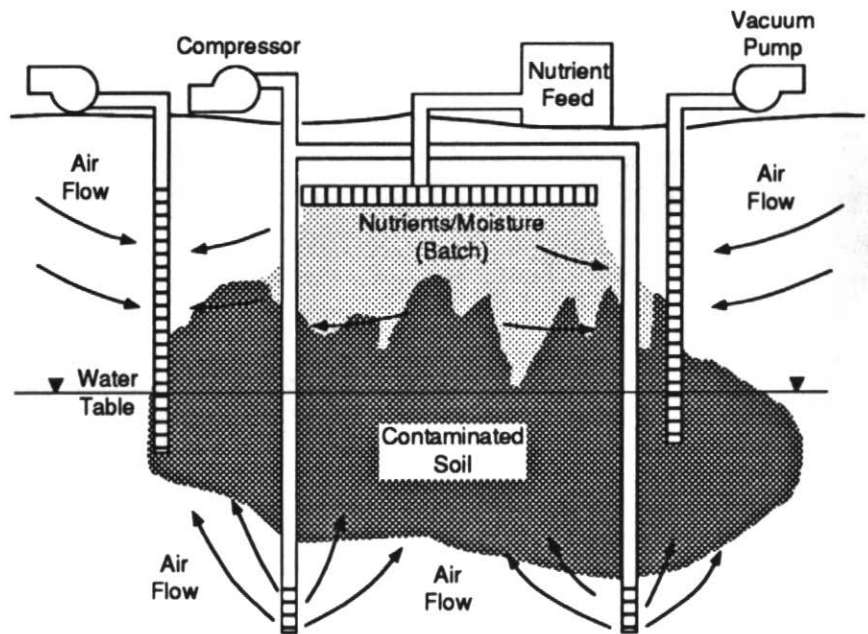

Figure 22 Air-sparging system with nutrient feed and vapour extraction (after National Research Council, 1993).

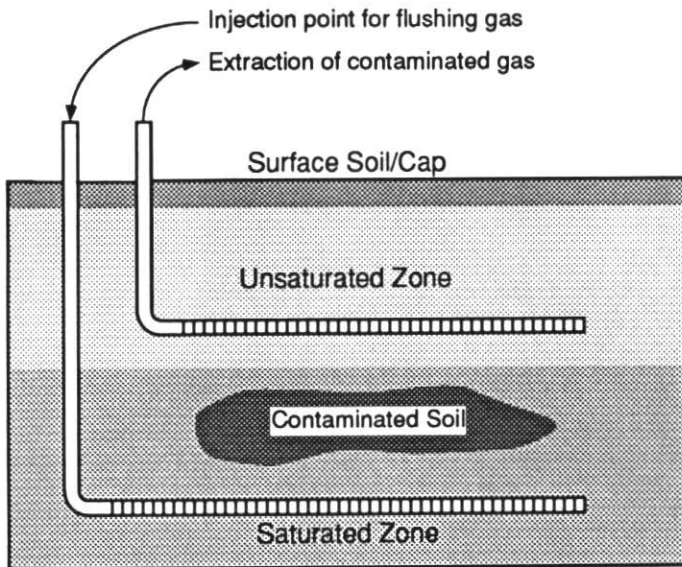

Figure 23 Air sparging using horizontal wells (after National Research Council, 1994).

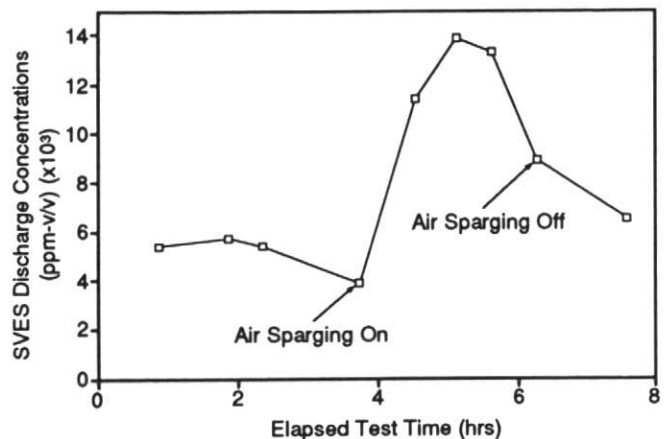

Figure 24 Impact of air sparging on concentrations of volatile organic compounds in soil vapour (after Marley et al., 1992).

ping. Pumped ground water may require treatment prior to discharge. The appropriate isolation method will depend on the mobility and toxicity of the contaminant and the intended use of the property.

Contaminated sites that are managed by isolation methods should be registered on title, and with regulatory agencies and local government building departments, so that existing and future owners and users are aware of the type, extent and location of the contaminants, in the event that redevelopment occurs or subsurface maintenance is required. As well, sites should be subject to long-term monitoring to ensure that containment features operate as designed, and contingency plans should be implemented in the event of containment failure. Isolation is often considered at those sites where clean-up is either technically or economically not feasible.

DISCUSSION

Soil and ground-water treatment tech-

nologies are continually evolving in an attempt to provide cost-effective solutions to contaminant clean-up problems. The remediation of soil and ground water to regulatory clean-up criteria has severe long-term economic implications relating to treatment costs and the abandonment and/or under use of contaminated land in prime urban settings (see Campbell *et al.*, in press for discussion). These conditions, along with the landfill ban on hazardous chemicals in some jurisdictions, have led to an increase in the use of alternative technologies. However, because of the relatively short time frame within which alternative technologies have developed, there is a general lack of good quality assessment information relating to the efficiency and applicability of specific technologies to a given contaminant problem. Part of the problem stems from the high cost of conducting such assessments, which typically includes third-party review of a given technology. Government-sponsored demonstration

programs have assisted in the evaluation of a number of treatment technologies.

In some situations, particularly in the application of *in situ* methods, the limiting factor to successful treatment is less an issue of technical performance of the technology, and more an issue of the understanding of subsurface conditions and the ability to control the treatment process in the subsurface. For example, heterogeneities in aquifer permeability may be sufficient to prevent groundwater removal from low-permeability zones within the area of contamination, resulting in inefficient and lengthy pumping. Heterogeneities also hinder the distribution of additives which are part of some *in situ* treatment methods (*e.g.*, surfactants, electron acceptors), consequently, contaminated fine-grained materials within and adjacent to an aquifer may be unaffected by pumping strategies or *in situ* treatment. In some situations, inadequate site characterization information and incomplete technology treatability studies can result in inappropriate or improper application of a technology.

Problems associated with soil and ground-water clean-up can include 1) inadequate site characterization; 2) insufficient vendor information indicating results of previous applications and in-

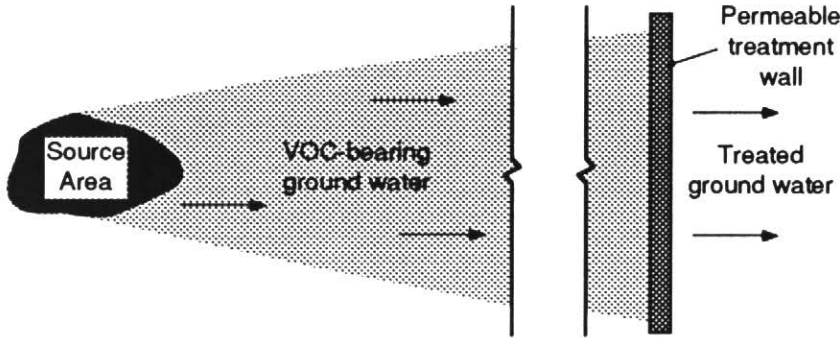

Figure 25 Schematic diagram of a reactive wall.

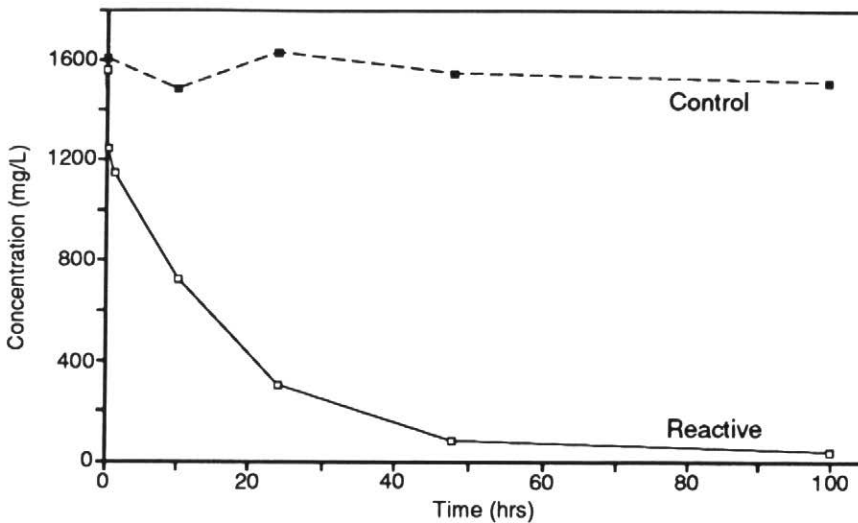

Figure 26 Degradation of TCE with reactive metal contact time.

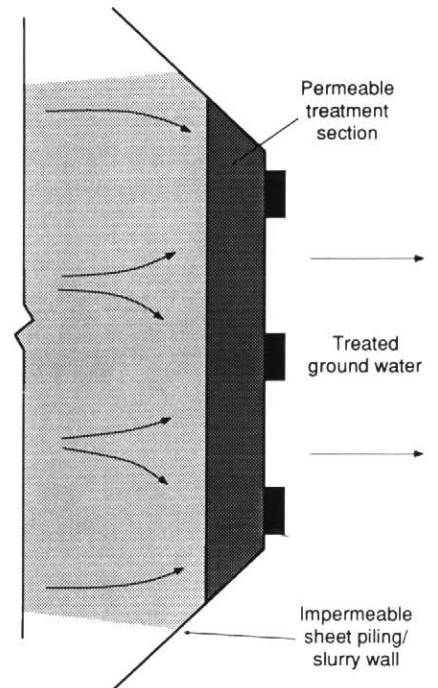

Figure 27 Schematic of funnel-and-gate technology.

dicating limitations of the technology; 3) incomplete treatment at the site; 4) inadequate monitoring to confirm clean-up; 5) inability of the clean-up program to meet clean-up criteria; and 6) difficulty in obtaining regulatory approvals. Ideally a vendor should be able to show application of his/her technology to the client's situation through 7) documentation of technology demonstration involving third party review; 8) documentation of technology through peer reviewed literature; 9) references of clients that used the technology; and 10) ability to conduct bench and/or pilot scale treatability studies of the technology using an industry accepted protocol that accounts for mass balance of the contaminant.

ACKNOWLEDGEMENTS

The figures were draughted by Mike Doughty.

REFERENCES

- Acar, Y.B. and Alshawabkeh, A.N., 1993, Principles of electrokinetic remediation: Environmental Science and Technology: v. 27, p. 2638-2647.
- Anderson, T.A., Guthrie, E.A. and Walton, B.T., 1993, Bioremediation in the rhizosphere: Environmental Science and Technology, v. 27, p. 2630-2636.
- Berezowsky, M., in press, Constructed wetlands for remediation of urban waste waters, in Eyles, N., ed., Environmental Geology of Urban Areas: Geological Association of Canada, St. John's, NF, in press.
- Brox, G.H. and Hanify, D.E., 1989, A new solid/liquid contact bioslurry reactor making bio-remediation more cost-competitive, in Superfund '89, Proceedings of the 10th National Conference, November 27-29, 1989, Washington D.C., p. 371-3.
- Campbell, M., Campbell, J., McKenna, S., MacRitchie, S. and Diamond, M., in press, Public health and urban soil contamination, in Eyles, N., ed., Environmental Geology of Urban Areas: Geological Association of Canada, St. John's, NF, in press.
- Coakley, J.P. and Mudroch, A., in press, Contaminated sediment in urban Great Lakes waterfronts, in Eyles, N., ed., Environmental Geology of Urban Areas: Geological Association of Canada, St. John's, NF, in press.
- Delthorn, R.T. and Mazzoni, A.F., 1986, Activated carbon, what it is, how it works: Water Technology, v. 9, p. 6-29.
- Domenico, P.A. and Schwartz, F.W., 1990, Physical and Chemical Hydrogeology: John Wiley & Sons, New York, 824 p.
- Feenstra, S., in press, Chlorinated solvents in urban ground waters, in Eyles, N., ed., Environmental Geology of Urban Areas: Geological Association of Canada, St. John's, NF, in press.
- François, J.-P. and Molyneux, H., in press, Hydrocarbon fuels in urban ground waters and soils, in Eyles, N., ed., Environmental Geology of Urban Areas: Geological Association of Canada, St. John's, NF, in press.
- Hubley, P.J., Panko, A.W. and Boocock, D.W., in press, On-site, ex situ bioremediation of petroleum-contaminated soils, in Eyles, N., ed., Environmental Geology of Urban Areas: Geological Association of Canada, St. John's, NF, in press.
- Hughes Environmental Systems Inc., 1992, Steam-enhanced recovery process, in Superfund Innovative Technology Evaluation Program Technology Profiles, Fifth Edition: EPA/540/R-92/077, Nov. 1992, p. 106-7.
- Jackson, R.F., Fountain, J.C. and Wunderlich, R.W., 1992, Chemically enhanced solubilization of DNAPL: Advancing the state of pump and treat remediation by injection and withdrawal of biodegradable surfactants: International Association of Hydrogeologists, Hamilton, Ontario, May 11-13, 1992, Proceedings, p. 104-116.
- Lageman, R., 1993, Electroreclamation: Environmental Science and Technology, v. 27, p. 2648-2650.
- Lehr, J.H., 1991, Granular Activated Carbon (GAC): Everyone knows of it, few understand it: Ground Water Monitoring Review, Fall 1991, p. 5-8.
- Marley, M.C. and Droste, E.X., 1995, Sparging strips trapped contaminants: International Ground Water Technology, v. 1, p. 18-23.
- Marley, M.C., Hazebrouck, D. and Walsh, M.T., 1992, The application of *in situ* air sparging as an innovative soils and groundwater remediation technology: Ground Water Monitoring Review, Spring, p. 137-144.
- Mercer, J.W., Skipp, D.C. and Giffin, D., 1990, Basics of Pump-and-Treat Ground-Water Remediation Technology: U.S. EPA--600/8-90/003, 31 p.
- National Research Council, 1993, In Situ Bioremediation — When Does It Work?: National Academy Press, Washington D.C. 207 p.
- National Research Council, 1994, Alternatives for Ground Water Cleanup: National Academy Press, Washington D.C., 315 p.
- O'Hannesin, S.F. and Gillham, R.W., 1992, A permeable reaction wall for *in situ* degradation of halogenated organic compounds [abstract]: 45th Canadian Geotechnical Society Conference, Toronto, Ontario, October 25-28, 1992, conference volume, p. 16.
- Ontario Ministry of Environment and Energy (OMOEE), 1994, Ontario's Environmental Technologies Program: Partnerships for a Cleaner Environment, Current Projects, 33 p.
- aven Beck Environmental Ltd, 1995, Report on demonstration projects for soil and ground water management at Ataratiri: prepared for the Waterfront Regeneration Trust, 42 p.
- Staps, J.J.M., 1990, International evaluation of *in situ* bioremediation of contaminated soil and groundwater: National Institute of Public Health and Environmental Protection, Bilthoven, The Netherlands, 192 p.
- Thomas, D.G. and Mackay, D.M., 1994, Oxygen enhancement of groundwater using a solid oxygen releasing compound [abstract]: Air and Waste Management Association Annual Conference, Burlington, Ontario, May 1-3, 1994, Proceedings, p. 12.
- Udell Technologies, Inc., 1992, In situ steam enhanced extraction, in Superfund Innovative Technology Evaluation Program Technology Profiles, Fifth Edition: EPA/540/R-92/077, Nov. 1992, p. 184-5.
- United States Environmental Protection Agency, 1989, Chemical on-site treatment utilizing KPEG process at Wide Beach, New York, in Demonstration of Remedial Action Technologies for Contaminated Land and Groundwater: NATO/CCMS Third International Conference, Montreal, Canada, p. 7-36.
- United States Environmental Protection Agency, 1991, Soil Vapour Extraction Technology Reference Handbook: EPA/540/2-91/003, 316 p.
- United States Environmental Protection Agency, 1992a, Chemical treatment and ultrafiltration: Emerging Technology Bulletin, SITE Program, EPA/540/F-92/002.
- United States Environmental Protection Agency, 1992b, Membrane filtration: Demonstration Bulletin, SITE Program, EPA/540/MR-92/014, 136 p.
- United States Environmental Protection Agency, 1992c, Electron beam treatment for removal of trichloroethylene and tetrachloroethylene from streams and sludge: Emerging Technology Bulletin, SITE Program, EPA/540/F-92/009, 51 p.
- United States Environmental Protection Agency, 1993a, Superfund Innovative Technology Evaluation Program, Technology Profiles, Sixth Edition EPA/540/R-93/526, 231 p.

- United States Environmental Protection Agency, 1993b, Hydraulic fracturing technology: applications analysis and technology evaluation report, EPA/540/R-93/505, 90 p.
- United States Environmental Protection Agency, 1993c, A cross-flow pervaporation system for removal of VOCs from contaminated wastewater: Emerging Technology Bulletin, SITE Program, EPA/540/F-93/503, 15 p.
- United States Environmental Protection Agency, 1993d, Microfiltration technology: Demonstration Bulletin, SITE Program, EPA/540/MR-93/513, 21 p.
- United States Environmental Protection Agency, 1993e, Peroxidation Systems, Inc. perox-pure chemical oxidation technology: Technology Demonstration Summary, SITE Program, EPA/540/SR-93/501, 6 p.
- United States Environmental Protection Agency, 1993f, Destruction of organic contaminants in air using advanced ultraviolet flashlamps: Emerging Technology Summary, SITE Program, EPA/540/MR-93/520, 10 p.
- United States Environmental Protection Agency, 1993g, CAV-OX Ultraviolet Oxidation Process Magnum Water Technology: Demonstration Bulletin, SITE Program, EPA/540/MR-93/520, 18 p.
- United States Environmental Protection Agency, 1993h, Electron beam treatment for the removal of benzene and toluene from aqueous streams and sludge: Emerging Technology Bulletin, SITE Program, EPA/540/F-93/502, 22 p.
- United States Environmental Protection Agency, 1993i, Removal of phenol from aqueous solutions using high energy electron beam irradiation: Emerging Technology Bulletin, SITE Program, EPA/540/F-93/509, 123 p.
- United States Environmental Protection Agency, 1994a, Innovative treatment technologies: Annual Status Report, Sixth Edition EPA 542-R-94-005, 37 p.
- United States Environmental Protection Agency, 1994b, Eco Logic International Gas Phase chemical reduction process and thermal desorption unit, Middleground Landfill, Bay City, MI: SITE Technology Demonstration Summary, EPA/540/5R-93/522, 8 p.